

## Série QR1



## Série QR1

Les raccords instantanés AVENTICS série QR1 à montage facile et sûr sont disponibles dans de nombreuses versions : pour les tuyaux de 3 à 16 mm de diamètre, ainsi qu'en variantes en plastique, en métal et en acier inoxydable. La série QR1 comporte un filetage cylindrique qui permet de répéter sans problème (libération rapide) le raccordement et le débranchement, ainsi qu'un joint torique avec protection contre la perte assurant une étanchéité optimale. Notre programme QR présente la solution adaptée à chaque application et à chaque secteur d'activité.

- $Q_n = 60 \text{ l/min} \dots 875 \text{ l/min}$
- En raison de l'optimisation des produits, l'article livré peut actuellement différer des dimensions représentées.



## Série QR1-S-RPN Standard

Raccord droit  
Filetage  
Raccord instantané



G	Ø D	Unité de livraison [Pcs.]	Référence
M5	Ø 4	10	2121004050
M5	Ø 6	10	2121006050

## 2121004050

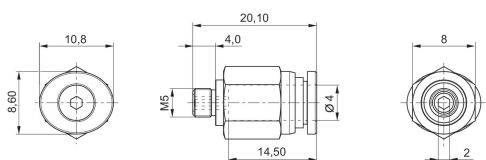

## 2121006050

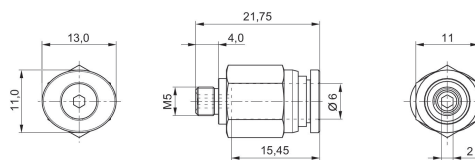

## Série QR1-S-RPN Standard

Raccord droit  
Filetage  
Raccord instantané



G	Ø D	Unité de livraison [Pcs.]	Référence
G 1/8	Ø 4	10	2121004180
G 1/8	Ø 6	10	2121006180
G 1/4	Ø 4	10	2121004140
G 1/4	Ø 6	10	2121006140
G 1/4	Ø 8	10	2121008140
G 3/8	Ø 6	10	R412005000
G 3/8	Ø 8	10	2121008380
G 3/8	Ø 10	10	2121010380
G 1/2	Ø 8	10	R412005001
G 1/2	Ø 10	10	2121010120
G 1/2	Ø 12	10	2121012120

## 2121004180

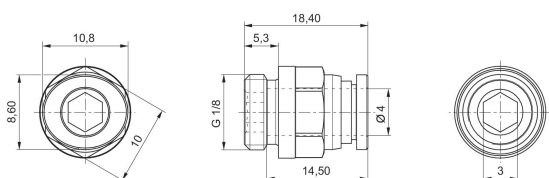

## 2121006180

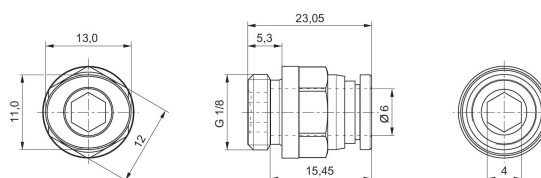

## 2121004140

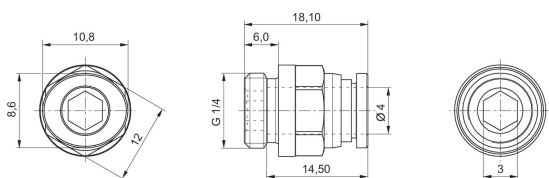

## 2121006140

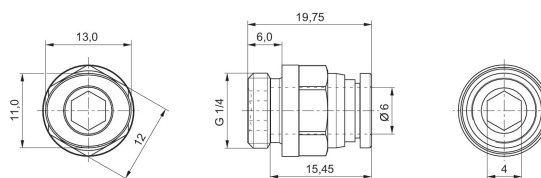

**2121008140**

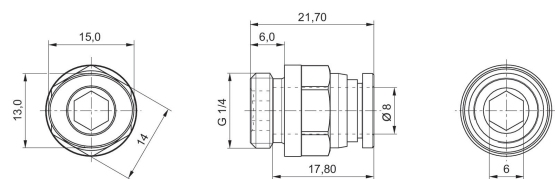

**R412005000**

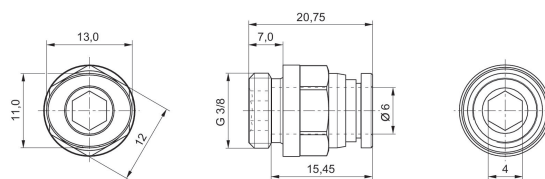

**2121008380**

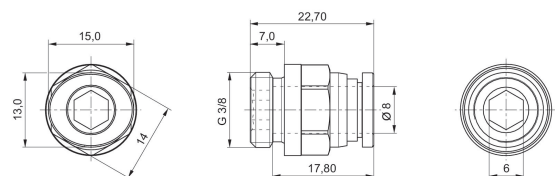

**2121010380**

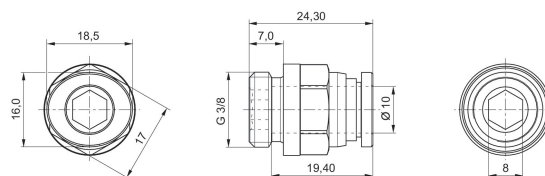

**R412005001**

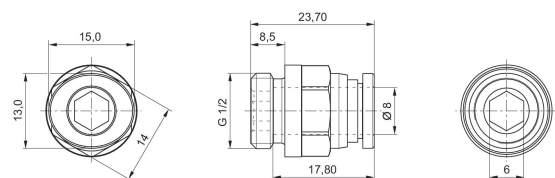

**2121010120**

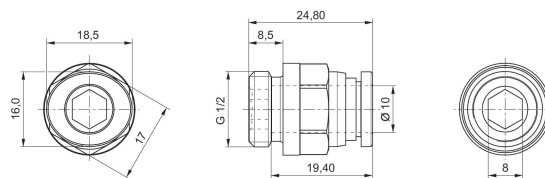

**2121012120**

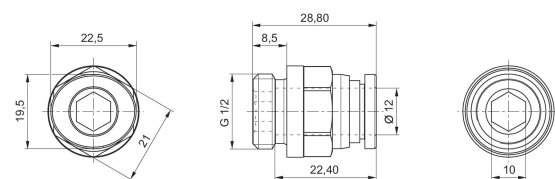

Série QR1-S-RPN Standard

Raccord droit  
Filetage  
Raccord instantané



G	Ø D	Unité de livraison [Pcs.]	Référence
G 1/8	Ø 8	10	2121008180
G 1/8	Ø 10	10	R412005002
G 1/8	Ø 12	10	R412005003
G 1/4	Ø 10	10	2121010140
G 1/4	Ø 12	10	2121012140
G 3/8	Ø 12	10	2121012380
G 3/8	Ø 14	10	2121014380
G 3/8	Ø16	10	R412005005
G 1/2	Ø 14	10	2121014120
G 1/2	Ø16	10	R412005006

2121008180

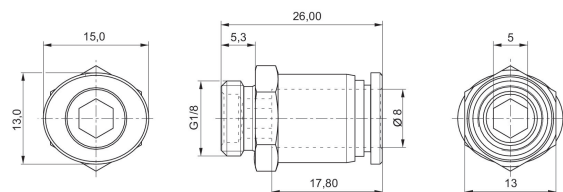

R412005002

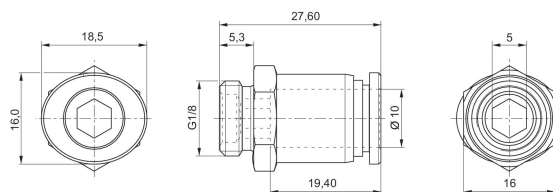

R412005003

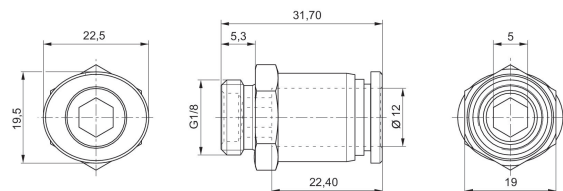

2121010140

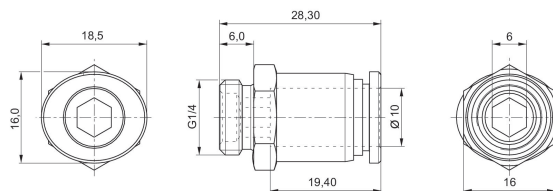

2121012140

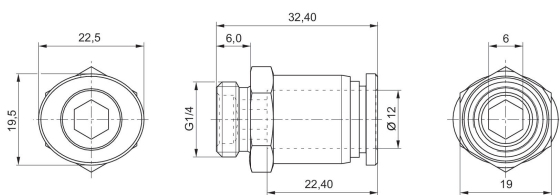

2121012380

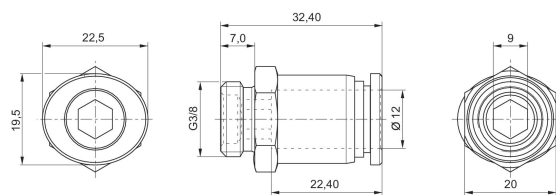

2121014380

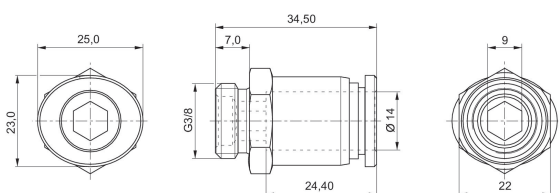

R412005005

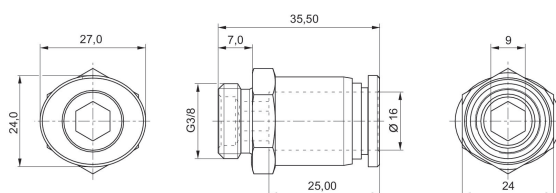

2121014120

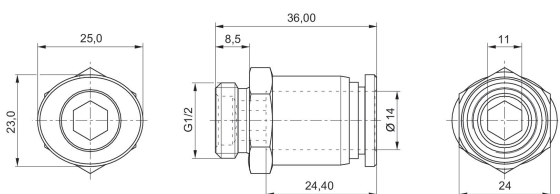

R412005006

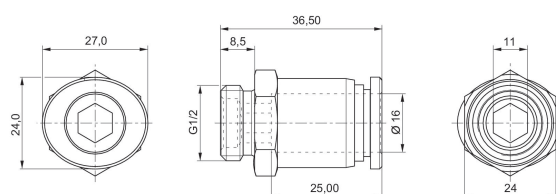

## Série QR1-S-RAS Standard

Raccord instantané  
Filetage  
Prise femelle



G	Ø D	Unité de livraison [Pcs.]	Référence
M5	Ø 4	10	2121604050
M5	Ø 6	10	R412005068
G 1/8	Ø 4	10	2121604180
G 1/8	Ø 6	10	2121606180
G 1/8	Ø 8	10	R412005071
G 1/4	Ø 6	10	2121606140
G 1/4	Ø 8	10	2121608140
G 1/4	Ø 10	10	R412005072
G 1/4	Ø 12	10	R412005073
G 3/8	Ø 10	10	2121610380
G 3/8	Ø 12	10	R412005074
G 1/2	Ø 10	10	2121610120
G 1/2	Ø 12	10	2121612120
G 1/2	Ø 14	5	R412005076
G 1/2	Ø 16	5	R412005078

## 2121604050

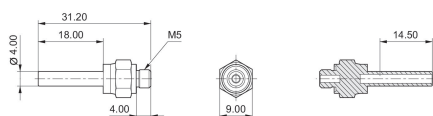

## R412005068

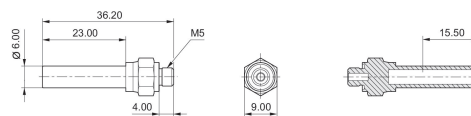

## 2121604180

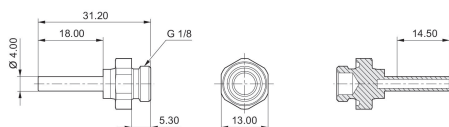

## 2121606180

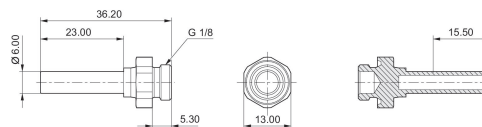



**R412005071**

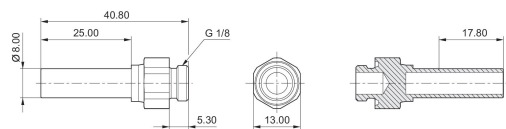

**2121606140**

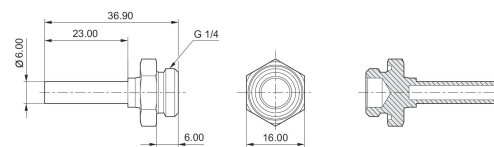

**2121608140**

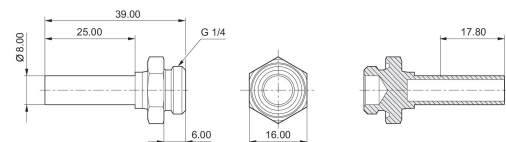

**R412005072**

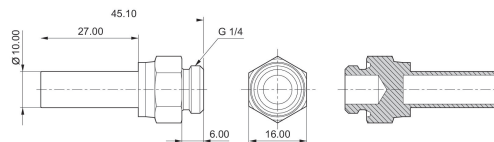

**R412005073**

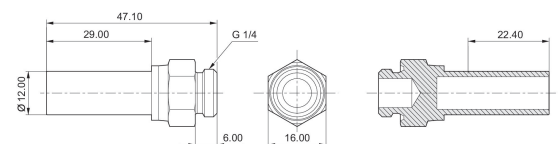

**2121610380**

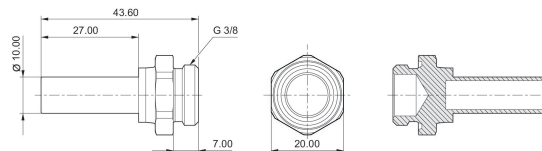

**R412005074, 2121610120**

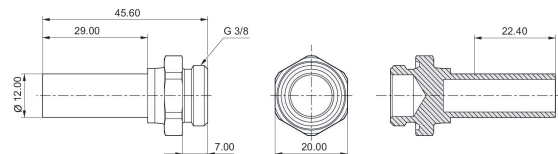

**2121612120**

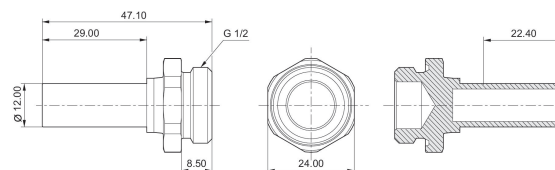

**R412005076**

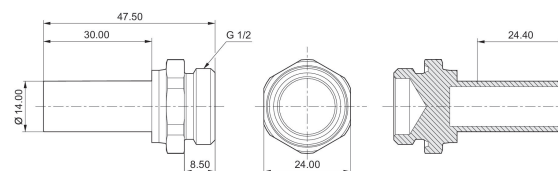

**R412005078**

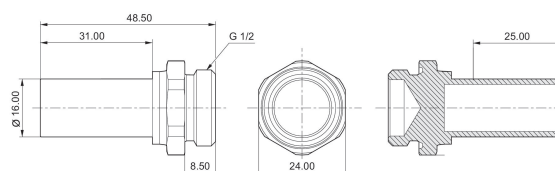

## Série QR1-S-RAI Standard

Raccord femelle droit  
Taraudage  
Raccord instantané

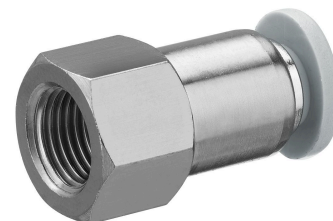

G	Ø D	Unité de livraison [Pcs.]	Référence
G 1/8	Ø 4	10	2121904180
G 1/8	Ø 6	10	2121906180
G 1/8	Ø 8	10	2121908180
G 1/4	Ø 4	10	R412005085
G 1/4	Ø 6	10	2121906140
G 1/4	Ø 8	10	2121908140
G 1/4	Ø 10	10	R412005089
G 1/4	Ø 12	10	R412005091
G 3/8	Ø 6	10	R412005086
G 3/8	Ø 8	10	R412005087
G 3/8	Ø 10	10	2121910380
G 3/8	Ø 12	10	2121912380
G 1/2	Ø 10	10	R412005090
G 1/2	Ø 12	10	2121912120

## 2121904180

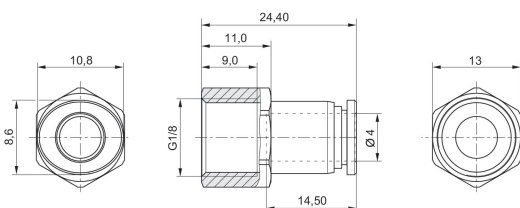

## 2121906180

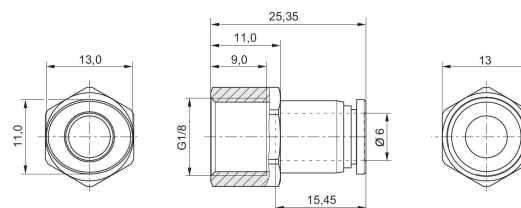

## 2121908180

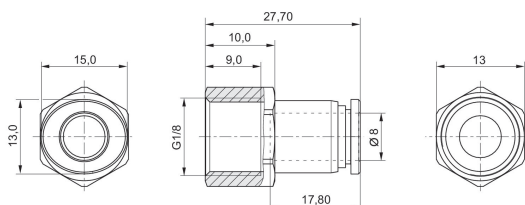

## R412005085

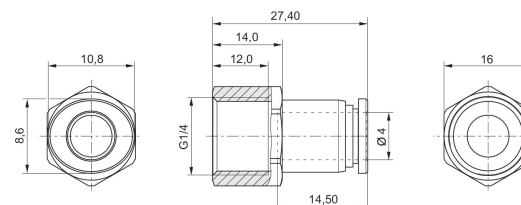

2121906140

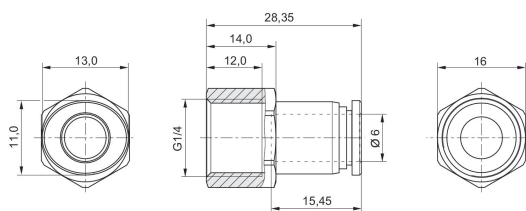

2121908140

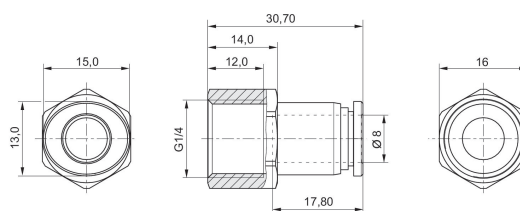

R412005089

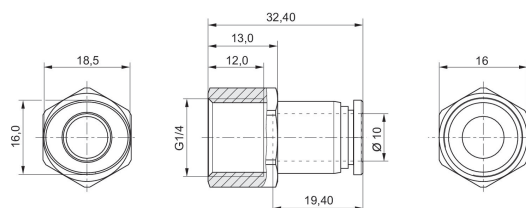

R412005091

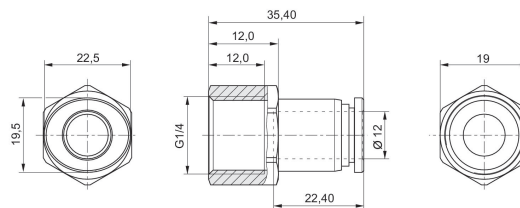

R412005086

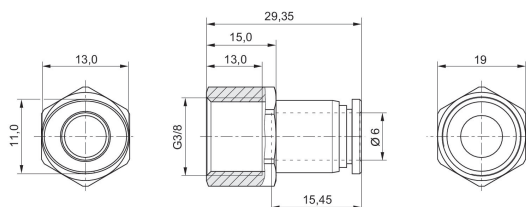

R412005087

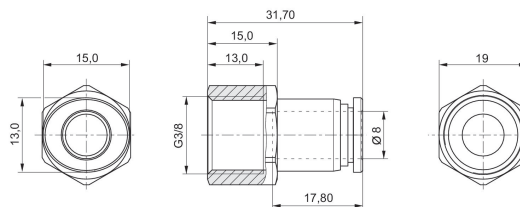

2121910380

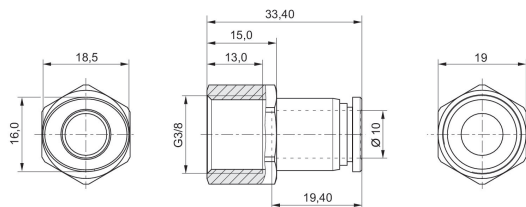

2121912380

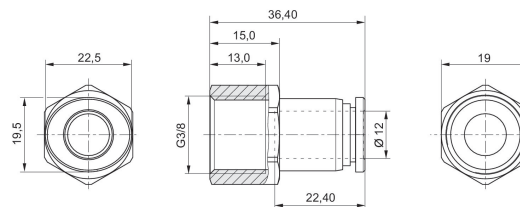

R412005090

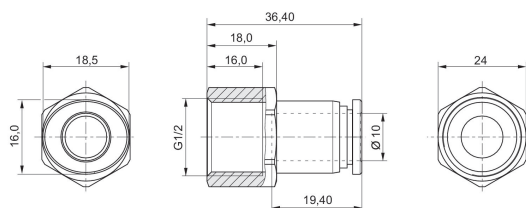

2121912120

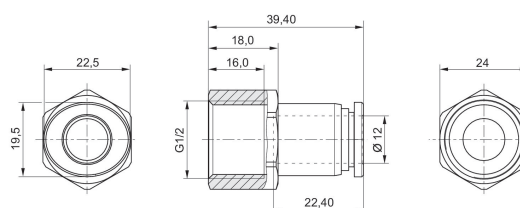

## Série QR1-S-RSI Standard

Traversée de cloison  
Taraudage  
Raccord instantané

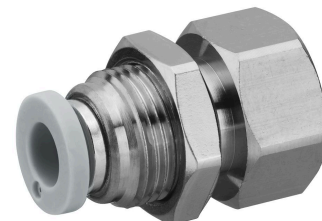

G	Ø D	Unité de livraison [Pcs.]	Référence
G 1/8	Ø 4	10	2122604180
G 1/8	Ø 6	10	2122606180
G 1/8	Ø 8	10	R412005232
G 1/4	Ø 6	10	2122606140
G 1/4	Ø 8	10	2122608140
G 1/4	Ø 10	10	R412005233
G 3/8	Ø 8	10	R412005231
G 3/8	Ø 10	10	2122610380
G 3/8	Ø 12	10	R412005235
G 1/2	Ø 12	10	2122612120

## 2122604180

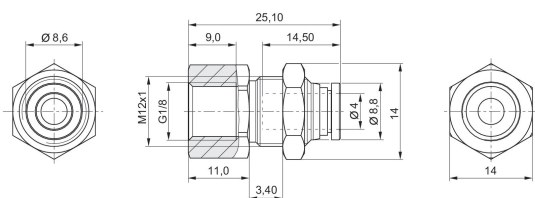

## 2122606180

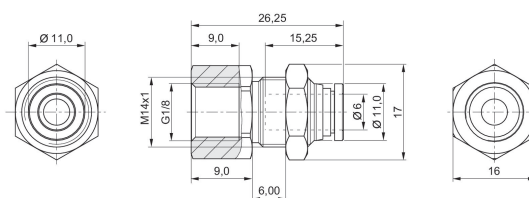

## R412005232

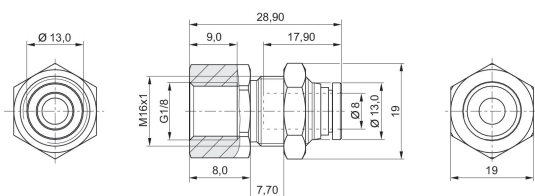

## 2122606140

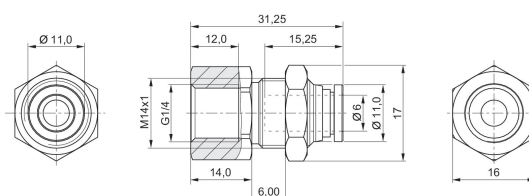

2122608140

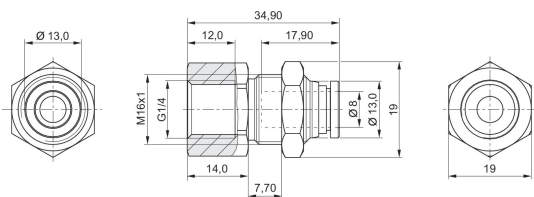

R412005233

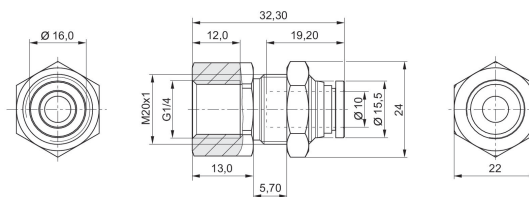

R412005231

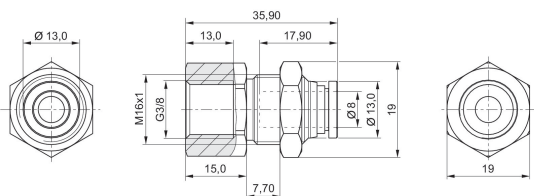

2122610380

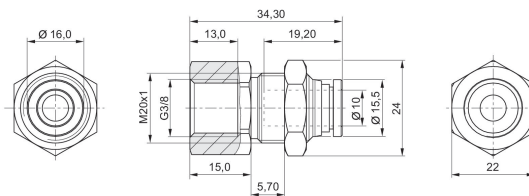

R412005235

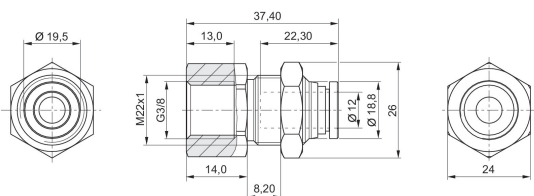

2122612120

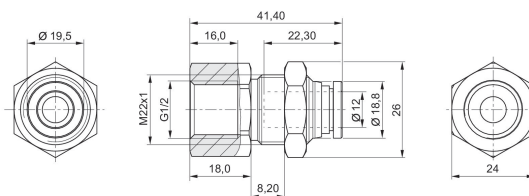

## Série QR1-S-RVT Standard

Raccord d'angle  
Filetage  
Raccord instantané



G	Ø D	Unité de livraison [Pcs.]	Référence
M5	Ø 4	10	2122004050
M5	Ø 6	10	2122006050

## 2122004050

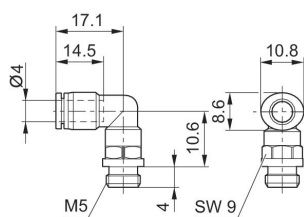

## 2122006050

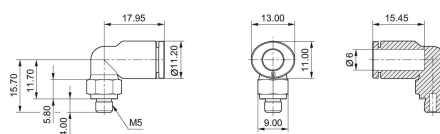

## Série QR1-S-RVT Standard

Raccord d'angle  
Filetage  
Raccord instantané



G	Ø D	Unité de livraison [Pcs.]	Référence
G 1/8	Ø 4	10	2122004180
G 1/8	Ø 6	10	2122006180
G 1/8	Ø 8	10	2122008180
G 1/8	Ø 10	10	R412005094
G 1/8	Ø 12	10	R412005095
G 1/4	Ø 4	10	2122004140
G 1/4	Ø 6	10	2122006140
G 1/4	Ø 8	10	2122008140
G 1/4	Ø 10	10	2122010140
G 1/4	Ø 12	10	2122012140
G 3/8	Ø 6	10	R412005092
G 3/8	Ø 8	10	2122008380
G 3/8	Ø 10	10	2122010380
G 3/8	Ø 12	10	2122012380
G 3/8	Ø 14	5	2122014380
G 3/8	Ø 16	5	R412005097
G 1/2	Ø 8	10	R412005093
G 1/2	Ø 10	10	2122010120
G 1/2	Ø 12	10	2122012120
G 1/2	Ø 14	5	2122014120
G 1/2	Ø 16	5	R412005098

## 2122004180

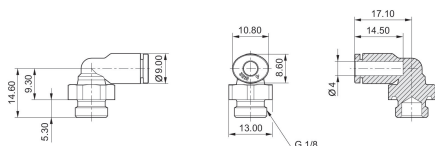

## 2122006180

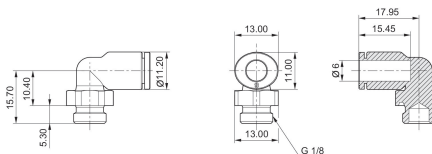

2122008180

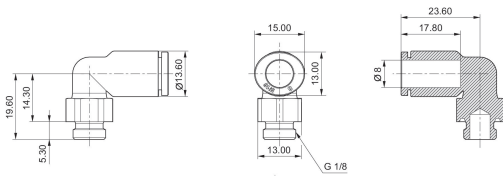

R412005094

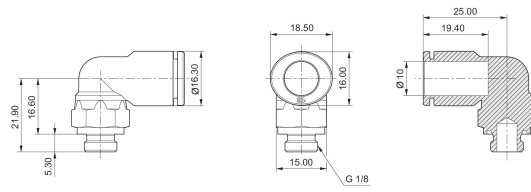

R412005095

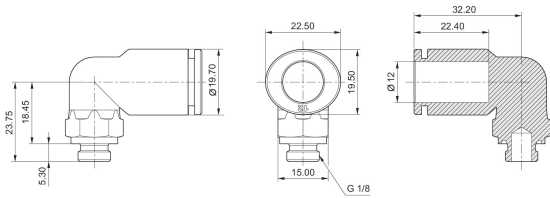

2122004140

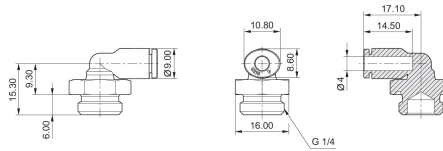

2122006140

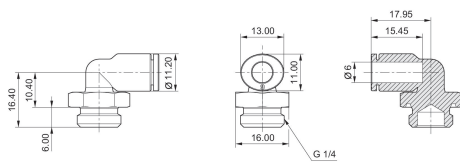

2122008140

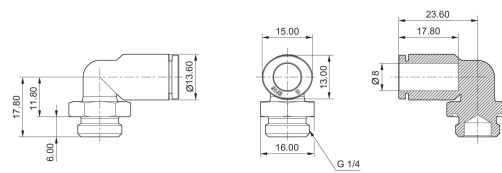

2122010140

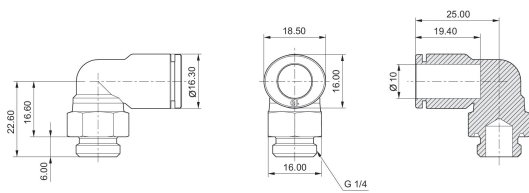

2122012140

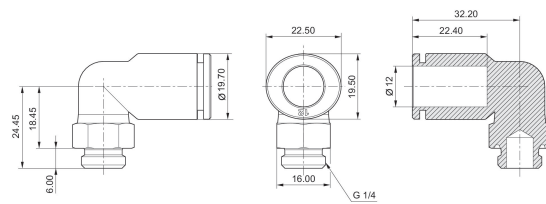

R412005092

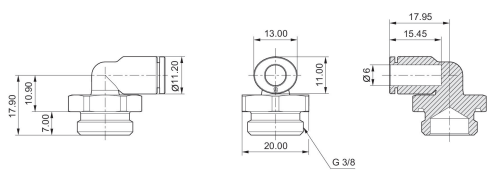

2122008380

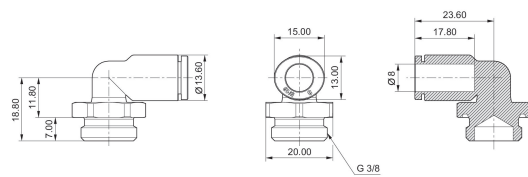



**2122010380**

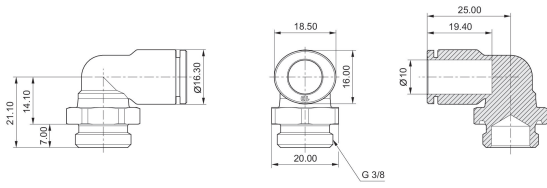

**2122012380**

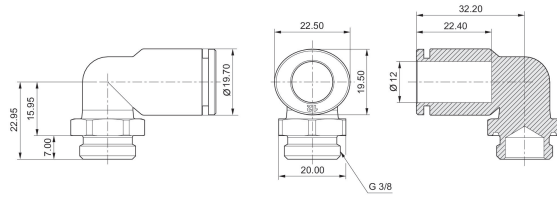

**2122014380**

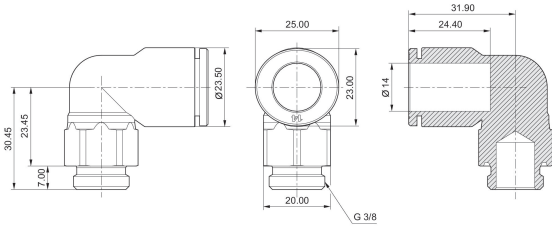

**R412005097**

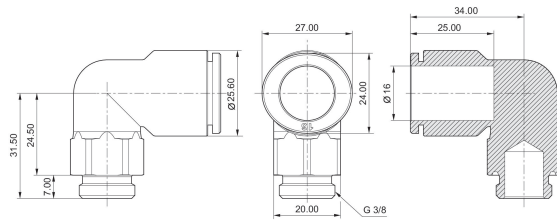

**R412005093**

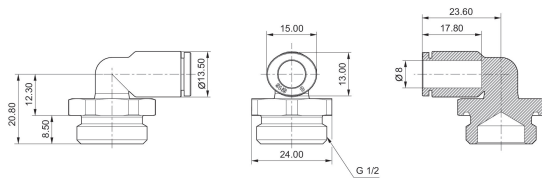

**2122010120**

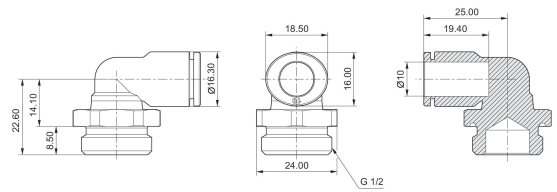

**2122012120**

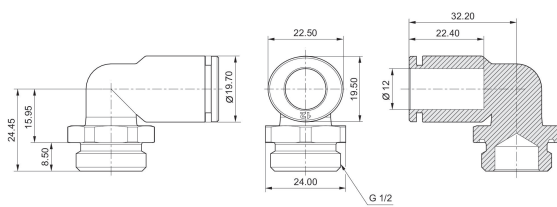

**2122014120**

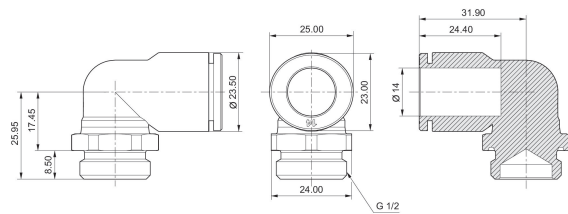

**R412005098**

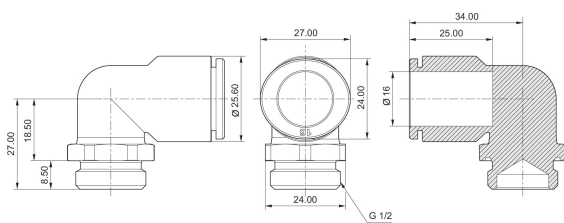

## Série QR1-S-RVL Standard

Raccord d'angle long  
Filetage  
Raccord instantané

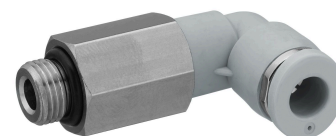

G	Ø D	Unité de livraison [Pcs.]	Référence
M5	Ø 4	10	2122104050
M5	Ø 6	10	R412005099
G 1/8	Ø 4	10	2122104180
G 1/8	Ø 6	10	2122106180
G 1/8	Ø 8	10	2122108180
G 1/4	Ø 4	10	2122104140
G 1/4	Ø 6	10	2122106140
G 1/4	Ø 8	10	2122108140
G 1/4	Ø 10	10	2122110140
G 1/4	Ø 12	10	R412005103
G 3/8	Ø 8	10	2122108380
G 3/8	Ø 10	10	2122110380
G 3/8	Ø 12	10	R412005104
G 1/2	Ø 12	10	R412005105

## 2122104050

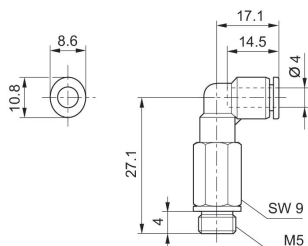

## R412005099

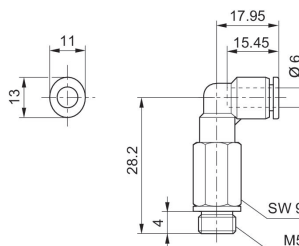

**2122104180**

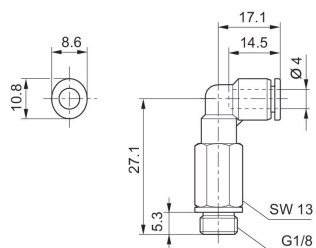

**2122106180**

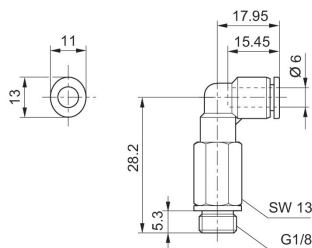

**2122108180**

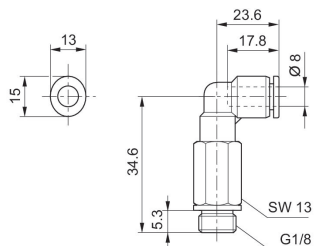

**2122104140**

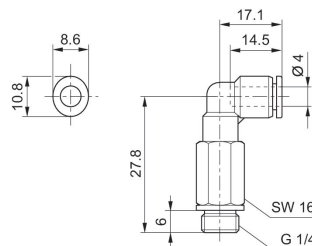

**2122106140**

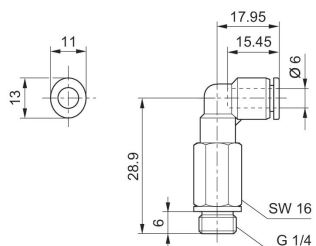

**2122108140**

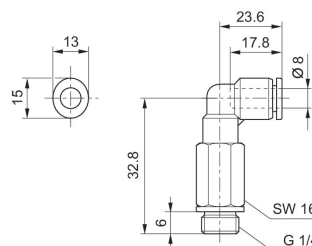

**2122110140**

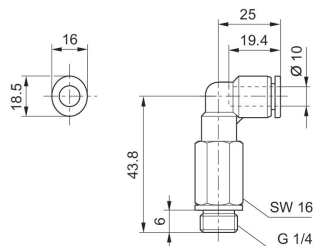

**R412005103**

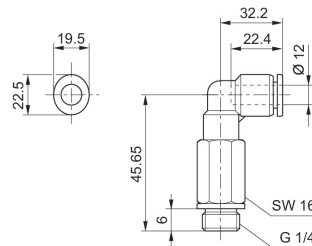

**2122108380**

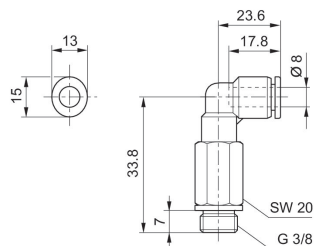

**2122110380**

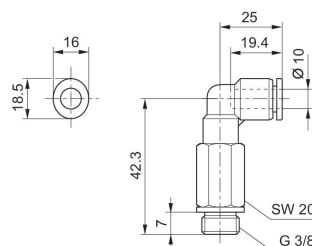

**R412005104**

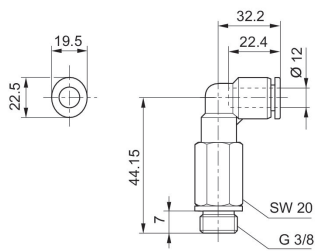

**R412005105**

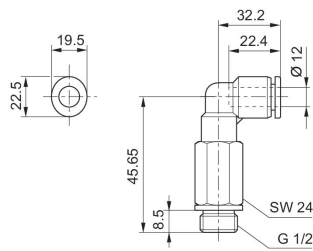

Série QR1-S-RVI Standard

Raccord d'angle femelle  
Taraudage  
Raccord instantané

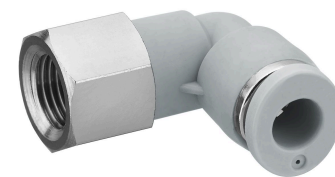

G	Ø D	Unité de livraison [Pcs.]	Référence
G 1/8	Ø 4	10	R412005129
G 1/8	Ø 6	10	R412005130
G 1/8	Ø 8	10	R412005131
G 1/4	Ø 4	10	R412005132
G 1/4	Ø 6	10	R412005133
G 1/4	Ø 8	10	R412005134
G 1/4	Ø 10	10	R412005135

R412005129

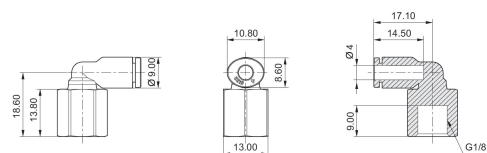

R412005130

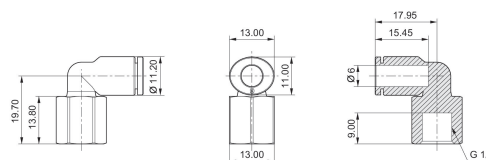

R412005131

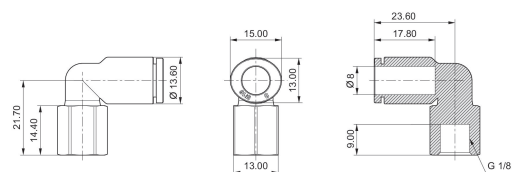

R412005132

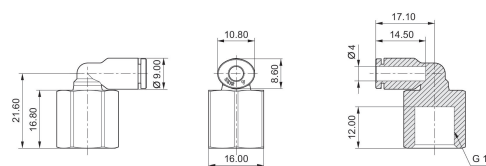

R412005133

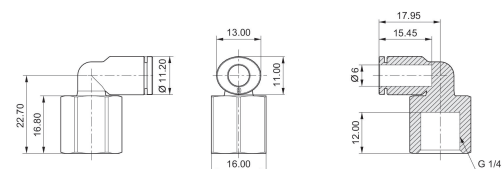

R412005134

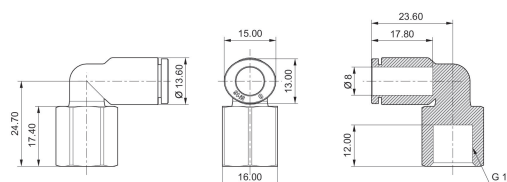

R412005135

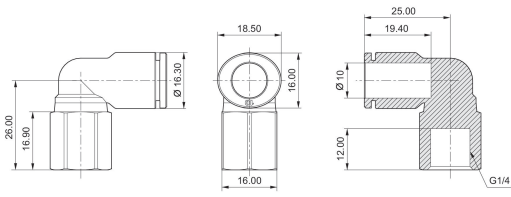

**Série QR1-S-RW1 Standard**

Raccord banjo simple  
Filetage  
Raccord instantané

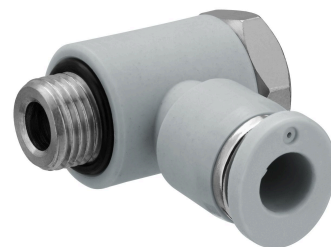

G	Ø D	Unité de livraison [Pcs.]	Référence
M5	Ø 4	10	R412005236
M5	Ø 6	10	R412005238

**R412005236**

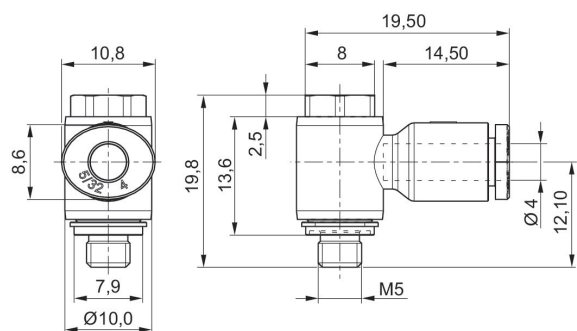

**R412005238**

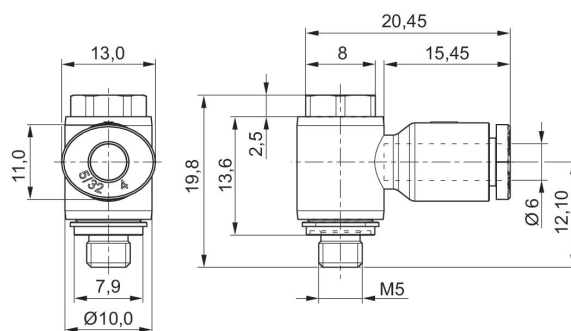

Série QR1-S-RW1 Standard

Raccord banjo simple  
Filetage  
Raccord instantané

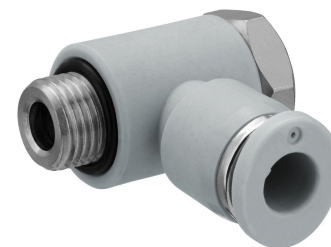

G	Ø D	Unité de livraison [Pcs.]	Référence
G 1/8	Ø 4	10	R412005237
G 1/8	Ø 6	10	R412005239
G 1/8	Ø 8	10	R412005240
G 1/4	Ø 6	10	R412005241
G 1/4	Ø 8	10	R412005242
G 1/4	Ø 10	10	R412005243
G 3/8	Ø 8	5	R412005244
G 3/8	Ø 10	5	R412005245
G 3/8	Ø 12	5	R412005246

R412005237

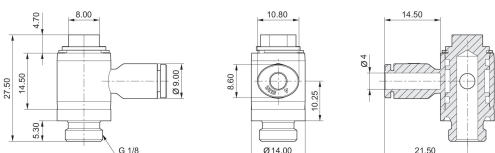

R412005239

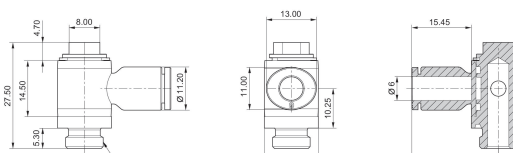

R412005240

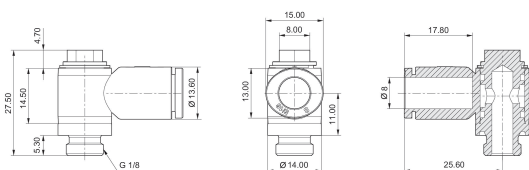

R412005241

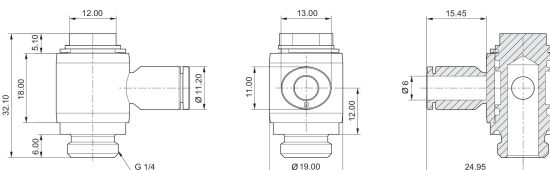

R412005242

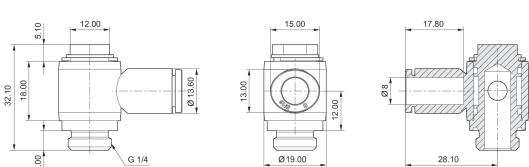

R412005243

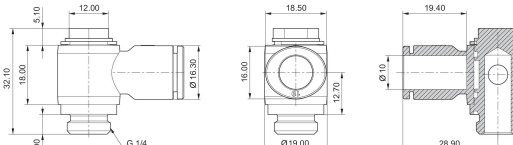



**R412005244**

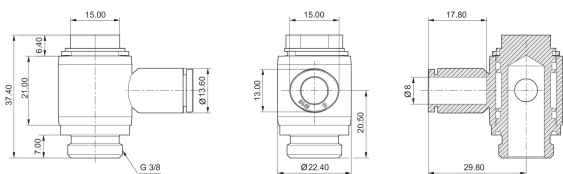

**R412005245**

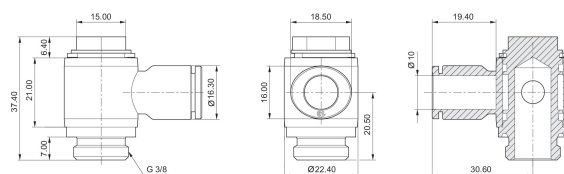

**R412005246**

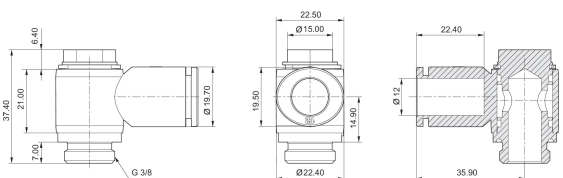

Série QR1-S-RW2 Standard

Raccord banjo double  
Filetage  
Raccord instantané



G	Ø D	Unité de livraison [Pcs.]	Référence
G 1/8	Ø 4	10	R412005141
G 1/8	Ø 6	10	R412005144
G 1/8	Ø 8	10	R412005147
G 1/4	Ø 6	10	R412005145
G 1/4	Ø 8	10	R412005148
G 3/8	Ø 8	10	R412005149
G 3/8	Ø 10	5	R412005152
G 1/2	Ø 12	5	R412005155

R412005141

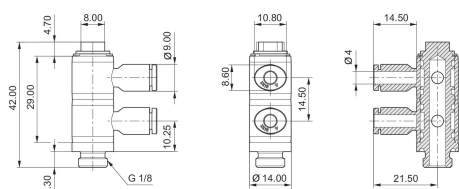

R412005144

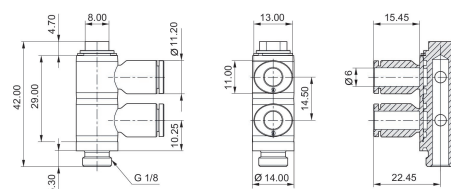

R412005147

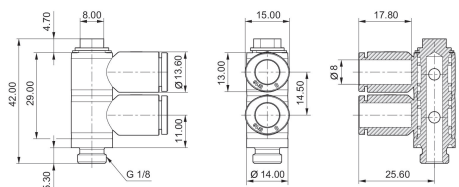

R412005145

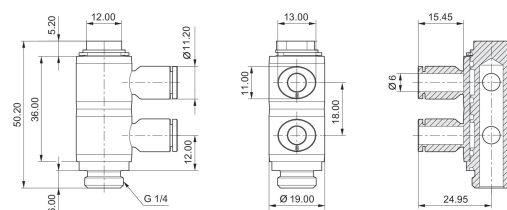

**R412005148**

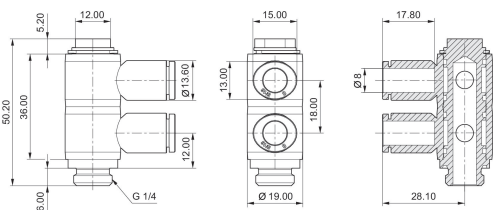

**R412005149**

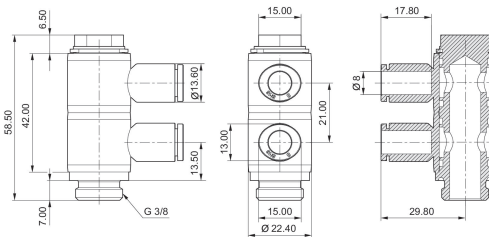

**R412005152**

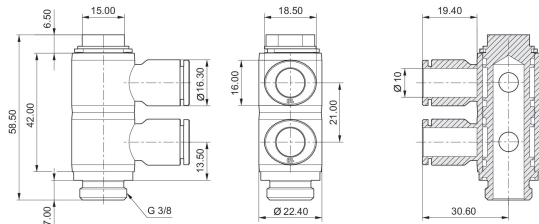

**R412005155**

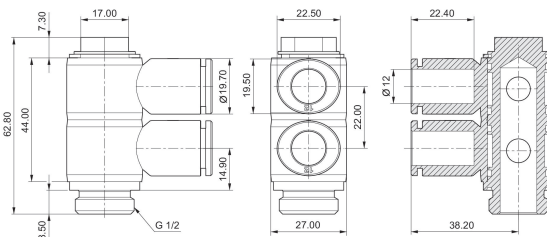

Série QR1-S-RW6 Standard

Raccord banjo triple, double  
Filetage  
Raccord instantané



G	Ø D	Unité de livraison [Pcs.]	Référence
G 1/8	Ø 4	10	R412005186
G 1/8	Ø 6	10	R412005187
G 1/4	Ø 4	10	R412005189
G 1/4	Ø 6	10	R412005190
G 1/4	Ø 8	10	R412005191
G 3/8	Ø 6	10	R412005194
G 3/8	Ø 8	10	R412005195
G 3/8	Ø 10	5	R412005196

R412005186

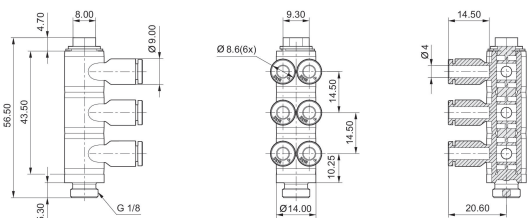

R412005187

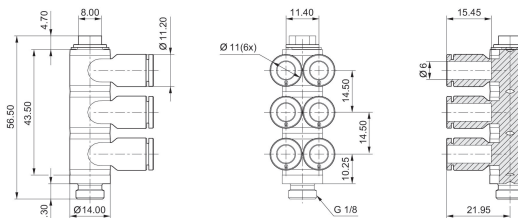

R412005189

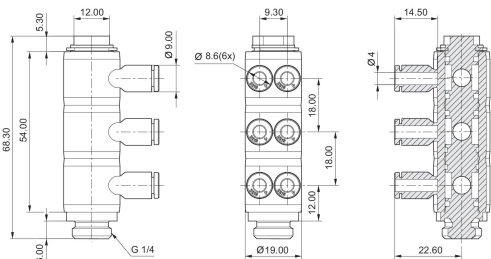

R412005190

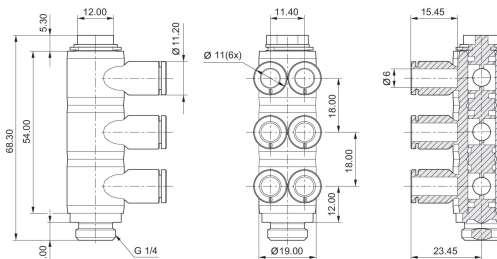

**R412005191**

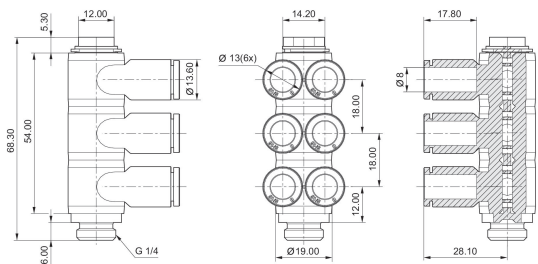

**R412005194**

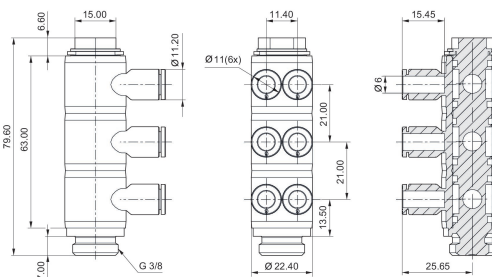

**R412005195**

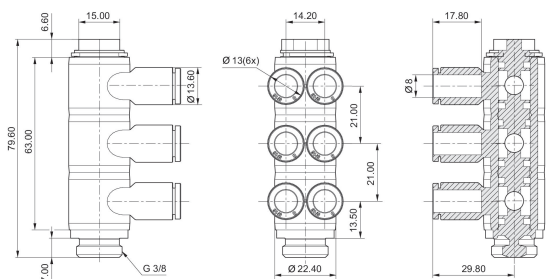

**R412005196**

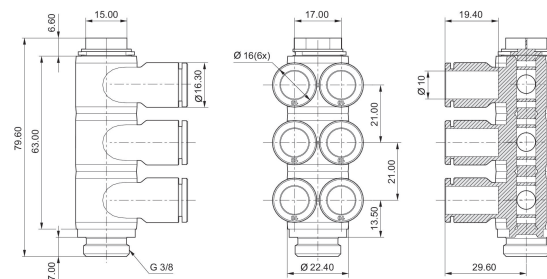

Série QR1-S-RID Standard

Raccord banjo double, avec filetage interne  
Filetage  
Raccord instantané



G	Ø D	Ø	Unité de livraison [Pcs.]	Référence
M5	Ø 4	M5	10	R412005259
G 1/8	Ø 6	G 1/8	10	R412005260
G 1/4	Ø 8	G 1/4	10	R412005261
G 3/8	Ø 10	G 3/8	5	R412005262

R412005259

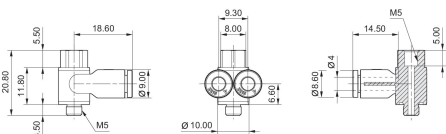

R412005260

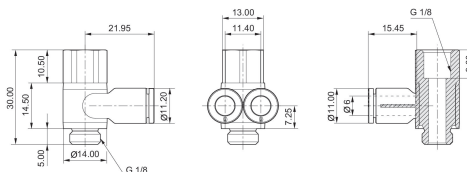

R412005261

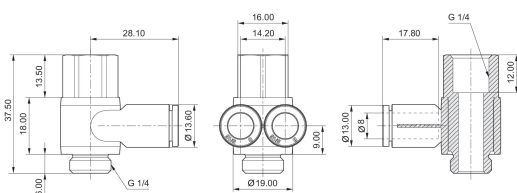

R412005262

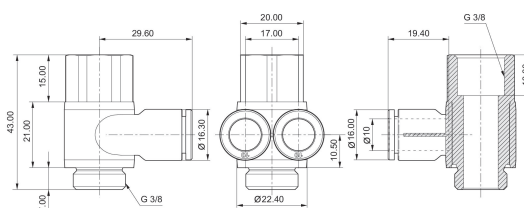

## Série QR1-S-RTT Standard

Raccord T  
Filetage  
Raccord instantané

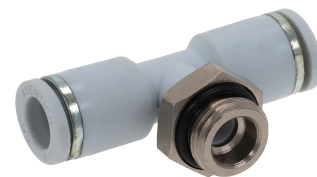

G	Ø D	Unité de livraison [Pcs.]	Référence
M5	Ø 4	10	2122204050
M5	Ø 6	10	R412005201
G 1/8	Ø 4	10	2122204180
G 1/8	Ø 6	10	2122206180
G 1/8	Ø 8	10	2122208180
G 1/8	Ø 10	10	R412005205
G 1/4	Ø 4	10	2122204140
G 1/4	Ø 6	10	2122206140
G 1/4	Ø 8	10	2122208140
G 1/4	Ø 10	10	2122210140
G 1/4	Ø 12	10	R412005206
G 3/8	Ø 6	10	R412005203
G 3/8	Ø 8	10	2122208380
G 3/8	Ø 10	10	2122210380
G 3/8	Ø 12	10	2122212380
G 3/8	Ø 14	10	2122214380
G 1/2	Ø 10	10	2122210120
G 1/2	Ø 12	5	2122212120
G 1/2	Ø 14	5	2122214120
G 1/2	Ø 16	5	R412005209

## 2122204050

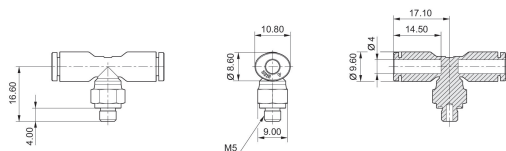

## R412005201

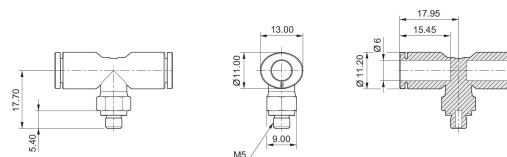

2122204180

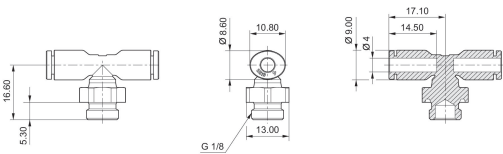

2122206180

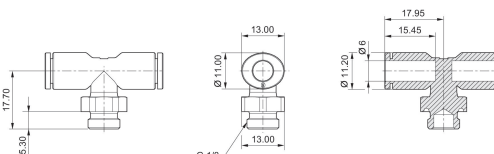

2122208180

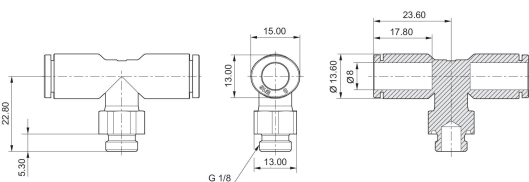

R412005205

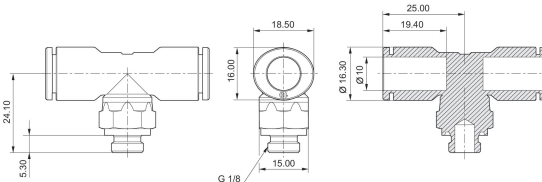

2122204140

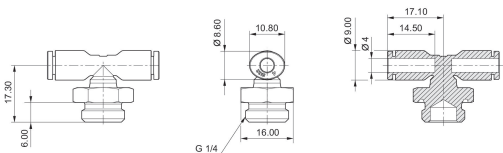

2122206140

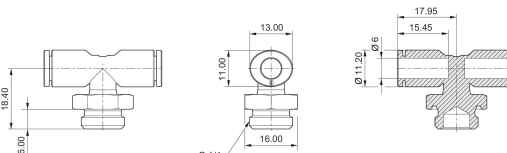

2122208140

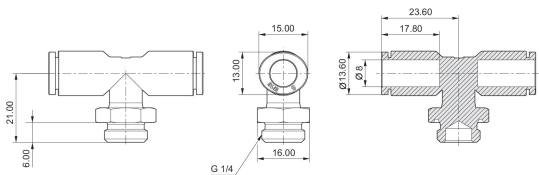

2122210140

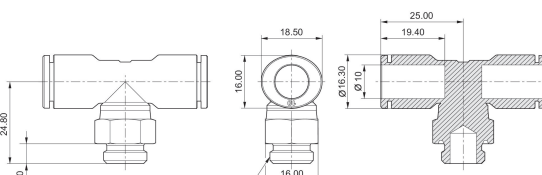

R412005206

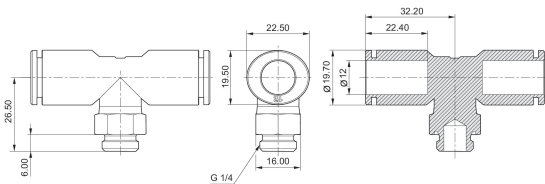

R412005203

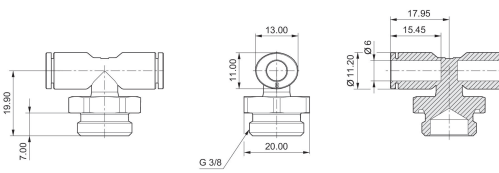

2122208380

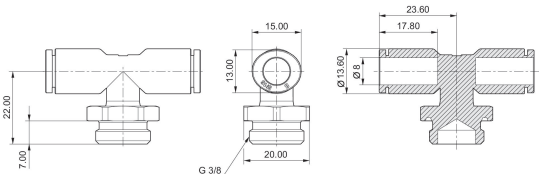

2122210380

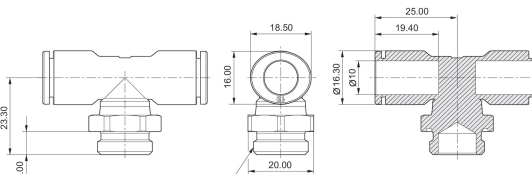



**2122212380**

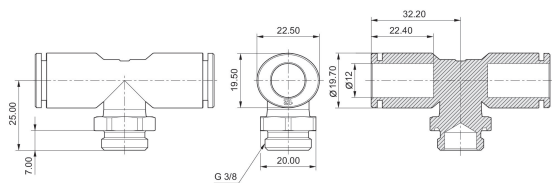

**2122214380**

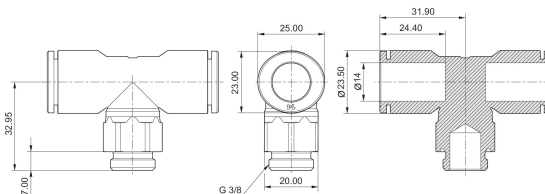

**2122210120**

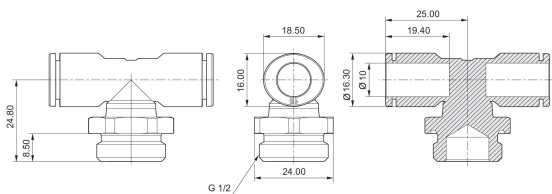

**2122212120**

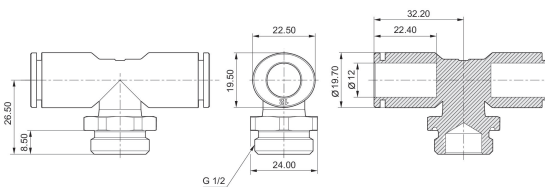

**2122214120**

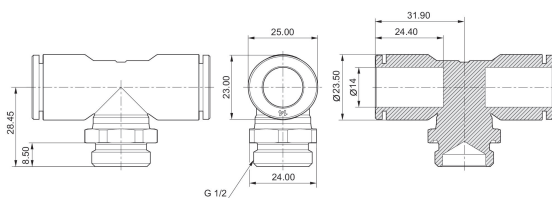

**R412005209**

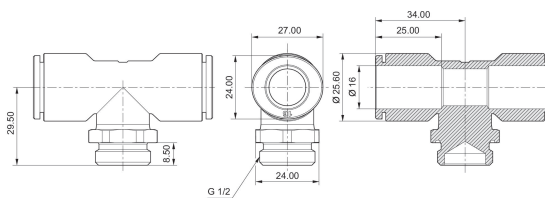

Série QR1-S-RTS Standard

Raccord banjo  
Filetage  
Raccord instantané

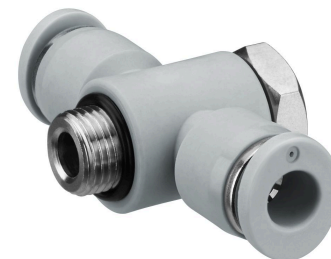

G	Ø D	Unité de livraison [Pcs.]	Référence
G 1/8	Ø 6	10	R412005292
G 1/8	Ø 8	10	R412005293
G 1/4	Ø 6	10	R412005294
G 1/4	Ø 8	10	R412005295

R412005292

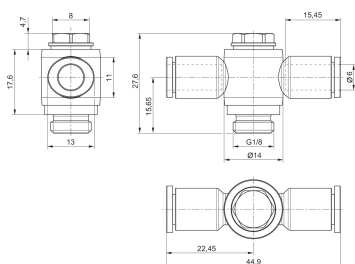

R412005293

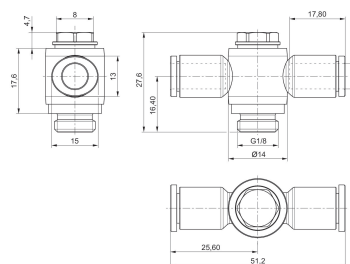

R412005294

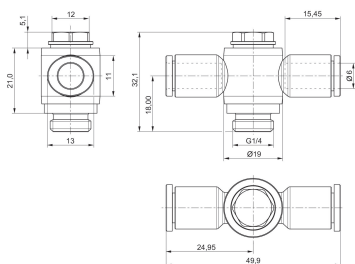

R412005295

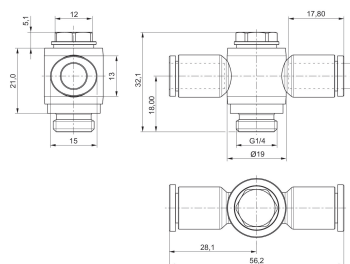

## Série QR1-S-RLT Standard

Vissage en L  
Filetage  
Raccord instantané

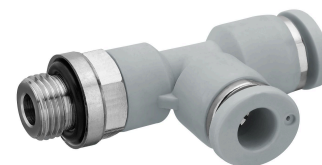

G	Ø D	Unité de livraison [Pcs.]	Référence
M5	Ø 4	10	2122304050
M5	Ø 6	10	R412005212
G 1/8	Ø 4	10	2122304180
G 1/8	Ø 6	10	2122306180
G 1/8	Ø 8	10	R412005214
G 1/4	Ø 4	10	R412005211
G 1/4	Ø 6	10	2122306140
G 1/4	Ø 8	10	2122308140
G 1/4	Ø 10	10	R412005215
G 1/4	Ø 12	5	R412005216
G 3/8	Ø 8	10	2122308380
G 3/8	Ø 10	10	2122310380
G 3/8	Ø 12	5	2122312380
G 1/2	Ø 10	10	2122310120
G 1/2	Ø 12	5	2122312120

## 2122304050

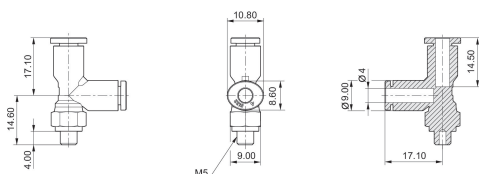

## R412005212

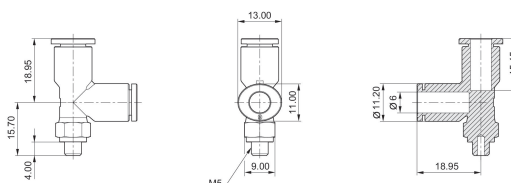

2122304180

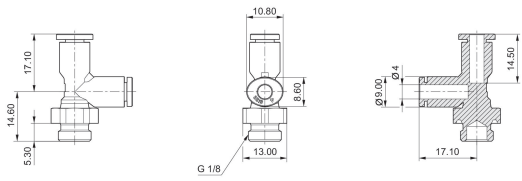

2122306180

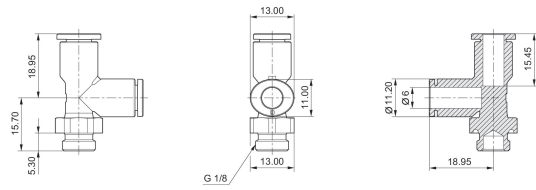

R412005214

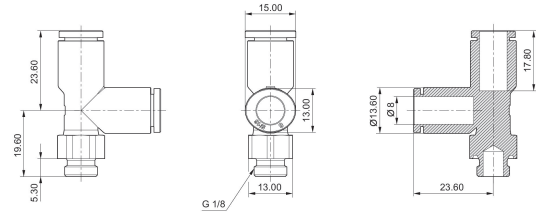

R412005211

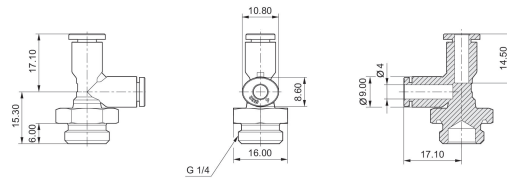

2122306140

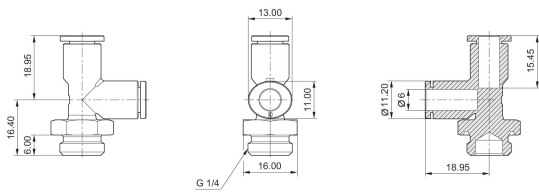

2122308140

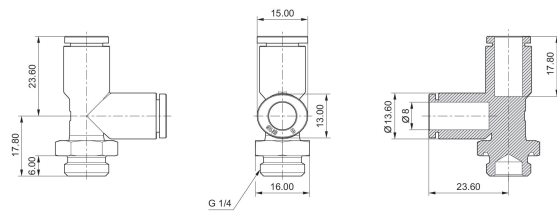

R412005215

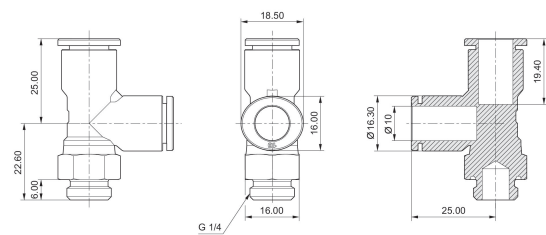

R412005216

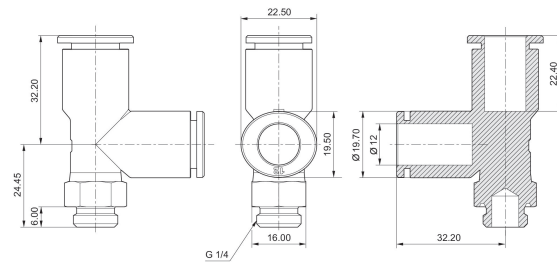

2122308380

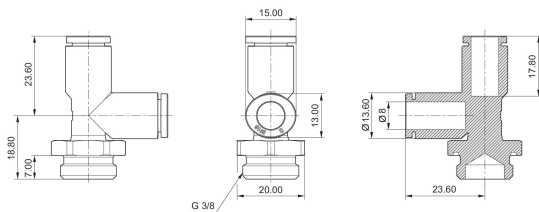

2122310380

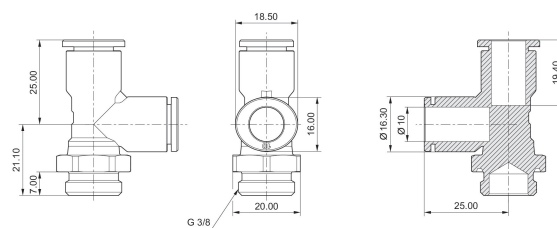

2122312380

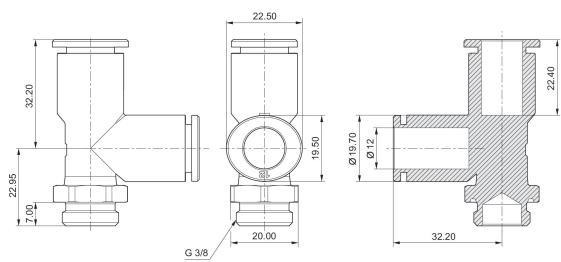

2122310120

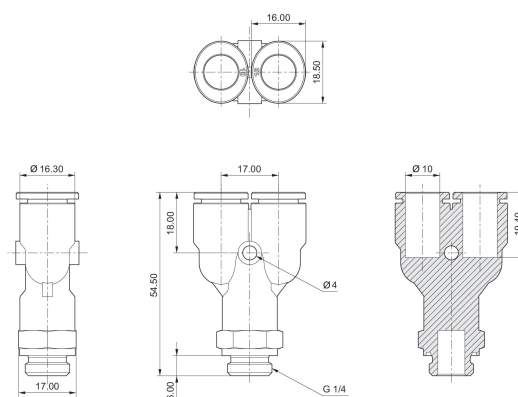

2122312120

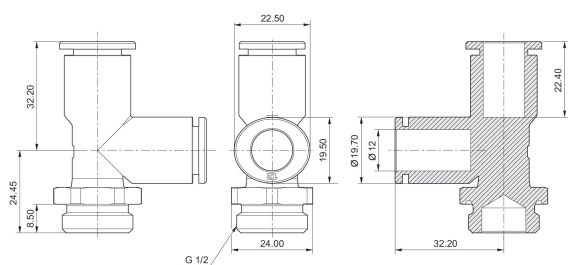

## Série QR1-S-RAY Standard

Raccord Y  
Filetage  
Raccord instantané



G	Ø D	Unité de livraison [Pcs.]	Référence
M5	Ø 4	10	2122404050
M5	Ø 6	10	R412005219
G 1/8	Ø 4	10	2122404180
G 1/8	Ø 6	10	2122406180
G 1/8	Ø 8	10	2122408180
G 1/4	Ø 4	10	2122404140
G 1/4	Ø 6	10	2122406140
G 1/4	Ø 8	10	2122408140
G 1/4	Ø 10	10	2122410140
G 3/8	Ø 8	10	R412005221
G 3/8	Ø 10	10	2122410380
G 3/8	Ø 12	10	2122412380
G 1/2	Ø 8	10	R412005222
G 1/2	Ø 10	10	2122410120
G 1/2	Ø 12	10	2122412120

## 2122404050

## R412005219

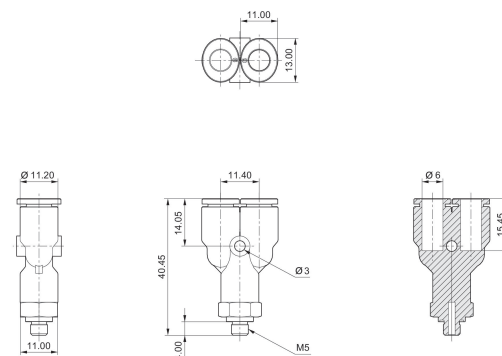
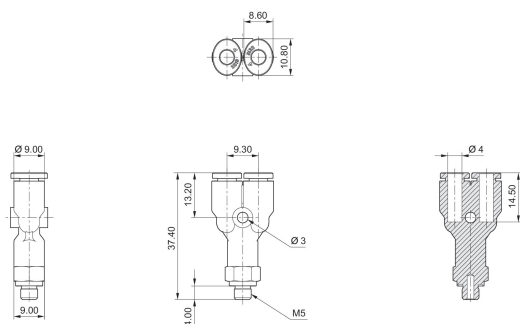

2122404180

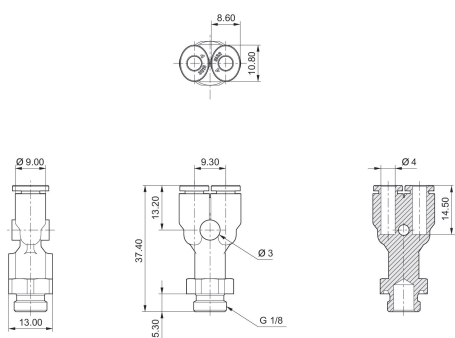

2122406180

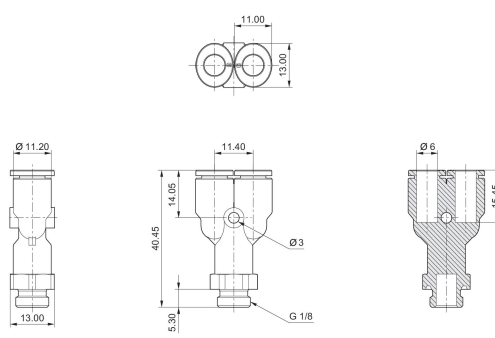

2122408180

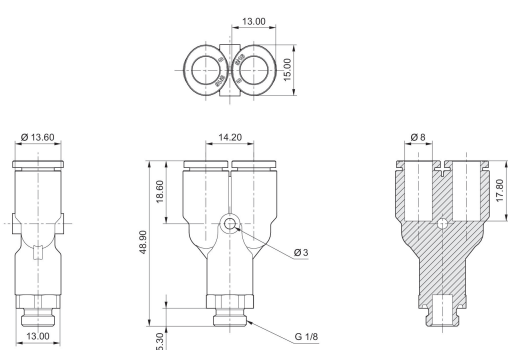

2122404140

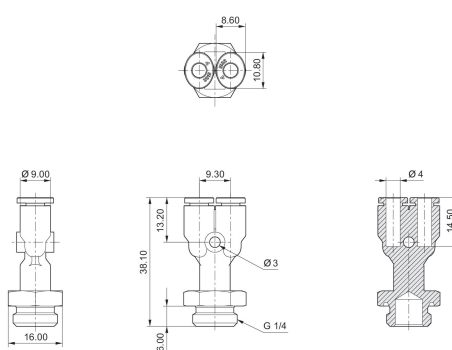

2122406140

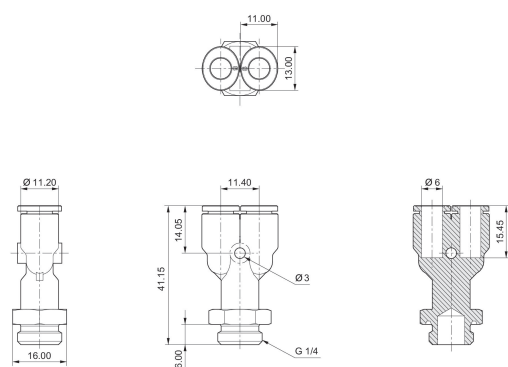

2122408140

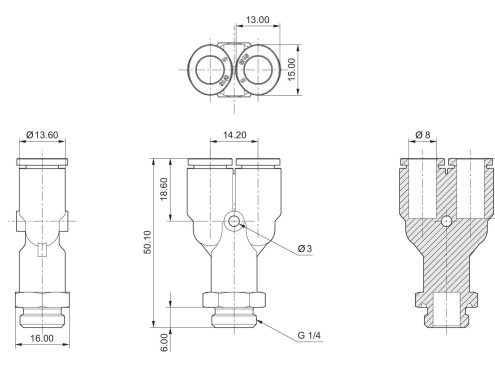

2122410140

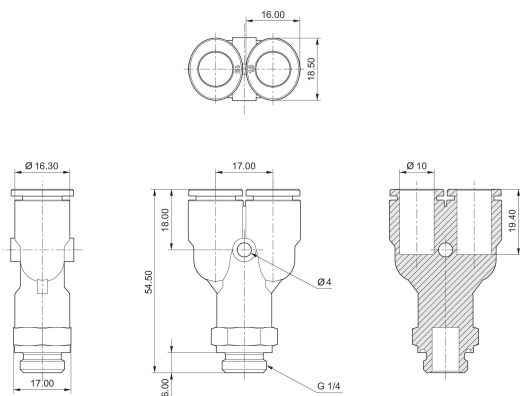

R412005221

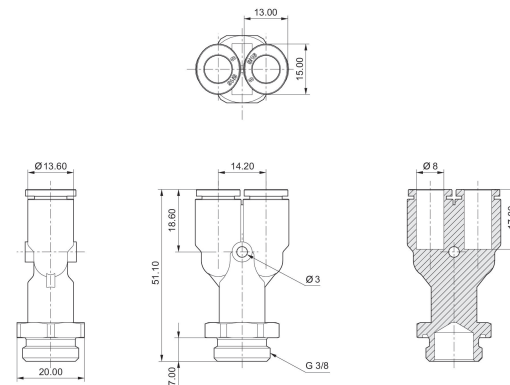

2122410380

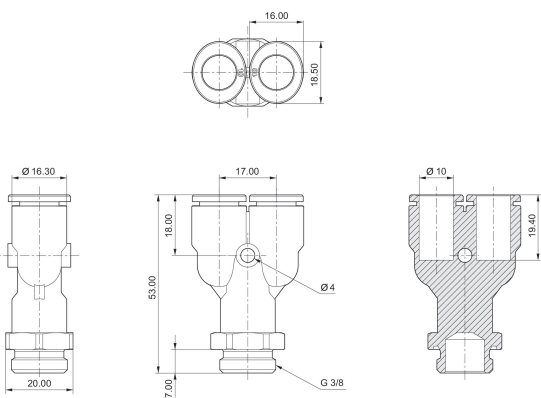

2122412380

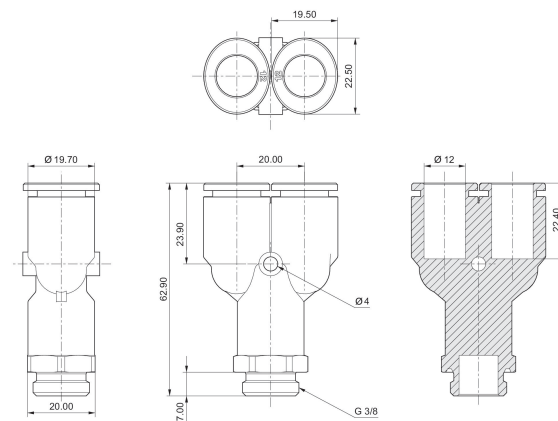

R412005222

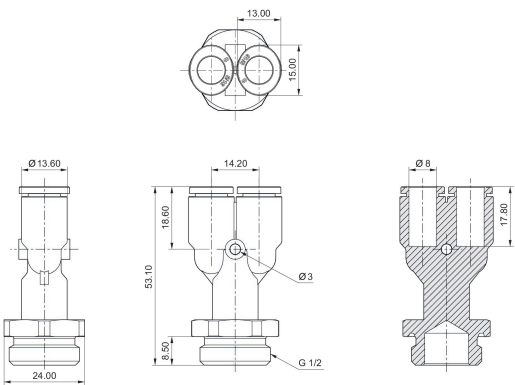

2122410120

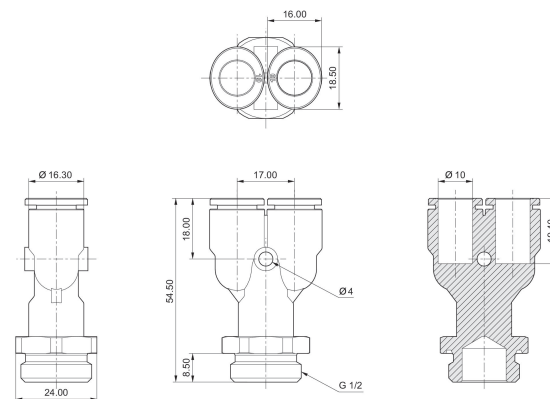



2122412120

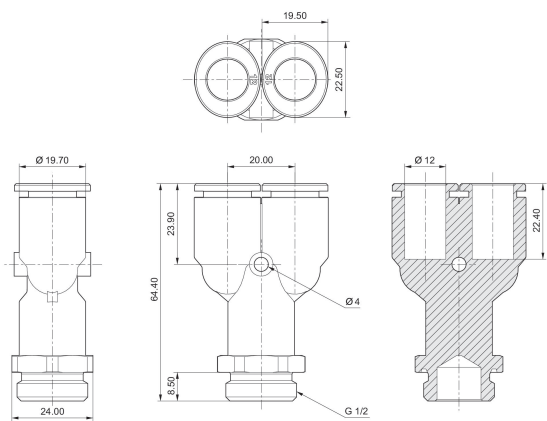

## Série QR1-S-RSK Standard

Raccord enfichable droit  
Raccord instantané  
Raccord instantané

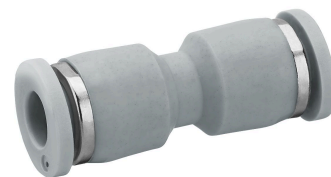

G	Ø D	Unité de livraison [Pcs.]	Référence
Ø 4	Ø 4	10	2121504000
Ø 6	Ø 6	10	2121506000
Ø 8	Ø 8	10	2121508000
Ø 10	Ø 10	10	2121510000
Ø 12	Ø 12	10	2121512000
Ø 14	Ø 14	5	2121514000
Ø 16	Ø 16	5	R412005059

## 2121504000

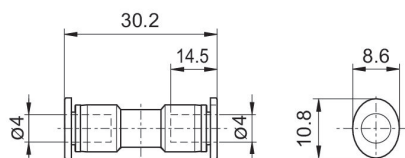

## 2121506000

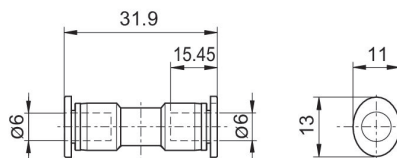

## 2121508000

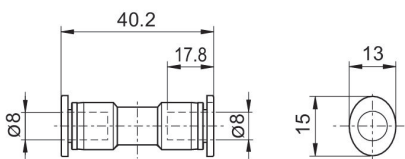

## 2121510000

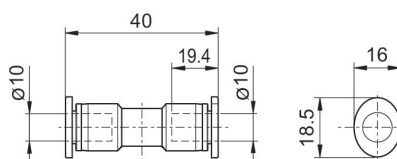

## 2121512000

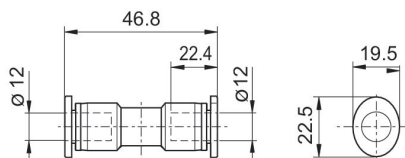

## 2121514000

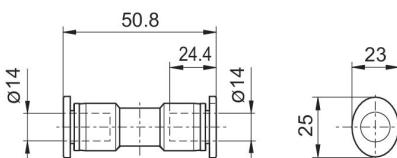

**R412005059**

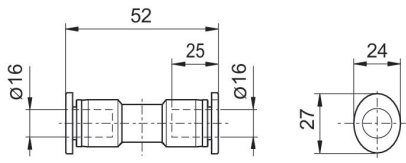

## Série QR1-S-RSR Standard

Raccord enfichable droit, réducteur

Raccord instantané

Raccord instantané

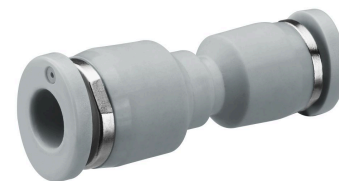

G	Ø D	Unité de livraison [Pcs.]	Référence
Ø 6	Ø 4	10	R412005060
Ø 8	Ø 4	10	R412005061
Ø 8	Ø 6	10	R412005062
Ø 10	Ø 6	10	R412005063
Ø 10	Ø 8	10	R412005064
Ø 12	Ø 8	10	R412005065
Ø 12	Ø 10	10	R412005066
Ø 16	Ø 12	5	R412005067

## R412005060

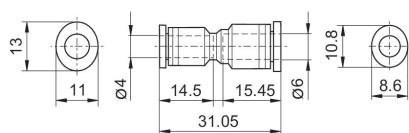

## R412005061

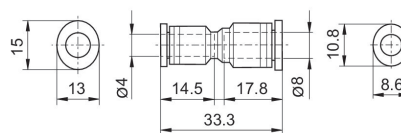

## R412005062

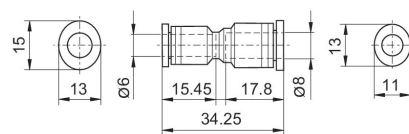

## R412005063

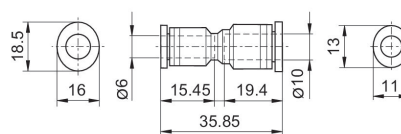

## R412005064

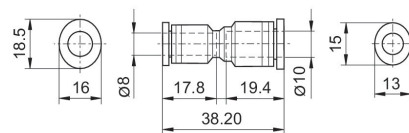

## R412005065

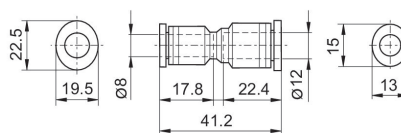

## R412005066

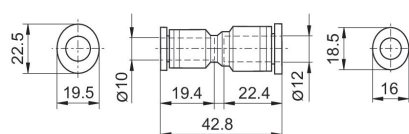

## R412005067

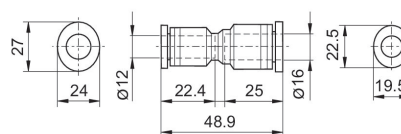

## Série QR1-S-RSM Standard

Raccord instantané Schott en métal

Raccord instantané

Raccord instantané



G	Ø D	Unité de livraison [Pcs.]	Référence
Ø 4	Ø 4	10	2121404000
Ø 6	Ø 6	10	2121406000
Ø 8	Ø 8	10	2121408000
Ø 10	Ø 10	10	2121410000
Ø 12	Ø 12	10	2121412000

## 2121404000

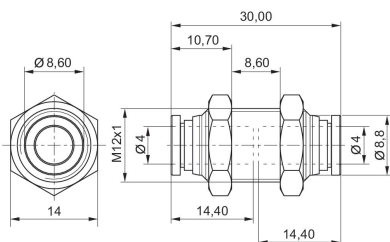

## 2121406000

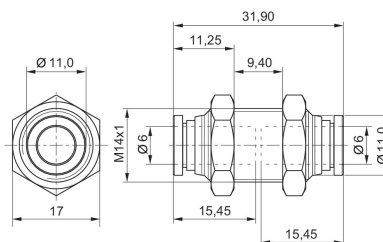

## 2121408000

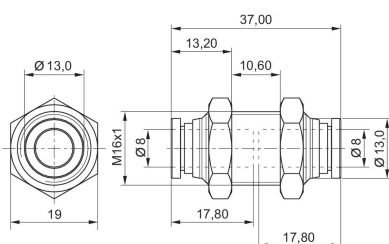

## 2121410000

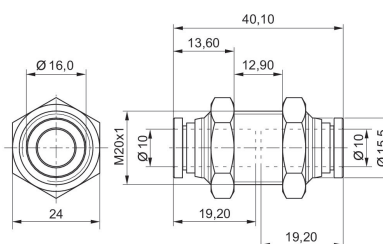

## 2121412000

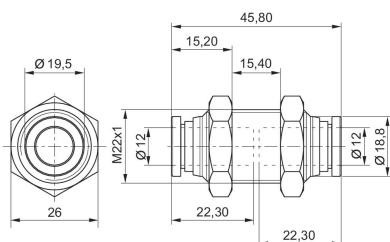

**Série QR1-S-RSC Standard**

Traversée de cloison, plastique  
Raccord instantané  
Raccord instantané



G	Ø D	Unité de livraison [Pcs.]	Référence
Ø 4	Ø 4	10	R412005051
Ø 6	Ø 6	10	R412005052
Ø 8	Ø 8	10	R412005053
Ø 10	Ø 10	10	R412005054
Ø 12	Ø 12	10	R412005055

**R412005051**

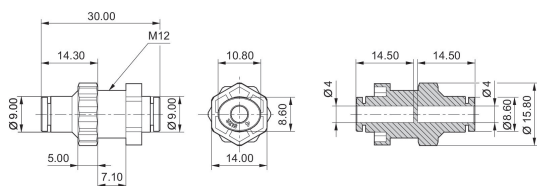

**R412005052**

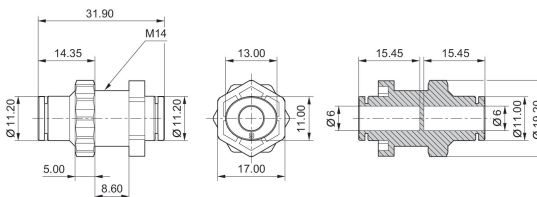

**R412005053**

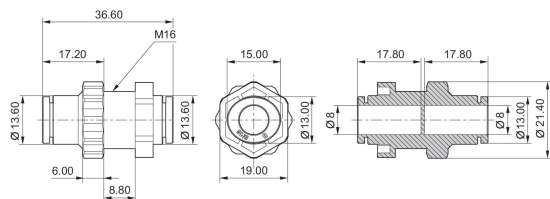

**R412005054**

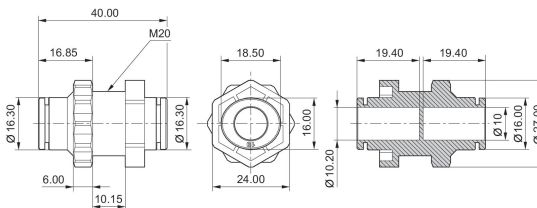

**R412005055**

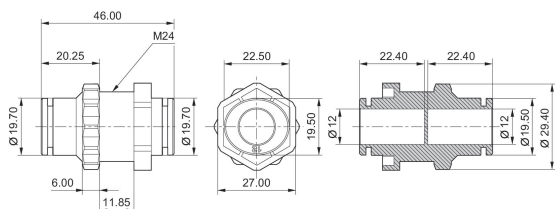

## Série QR1-S-RVW Mini

Raccord instantané angulaire  
Prise femelle  
Raccord instantané



G	Ø D	Unité de livraison [Pcs.]	Référence
Ø 4	Ø 4	10	R412005046

## Dimensions

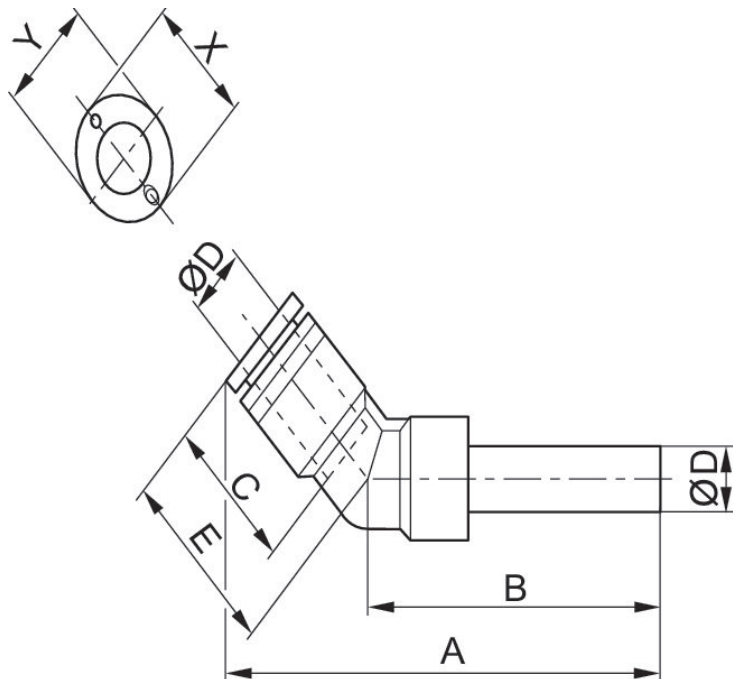

Référence	Orifice D	Orifice G	A	B	C	E	X	Y
R412005046	Ø 4	Ø 4	56,36	43,6	16	18.1	12	10

## Série QR1-S-RVK Standard

Raccord d'angle enfichable  
Raccord instantané  
Raccord instantané

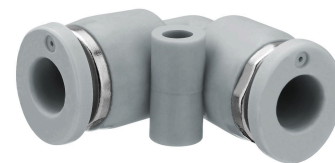

G	Ø D	Unité de livraison [Pcs.]	Référence
Ø 4	Ø 4	10	2121204000
Ø 6	Ø 6	10	2121206000
Ø 8	Ø 8	10	2121208000
Ø 10	Ø 10	10	2121210000
Ø 12	Ø 12	10	2121212000
Ø 14	Ø 14	5	2121214000
Ø 16	Ø 16	5	R412005033

## 2121204000

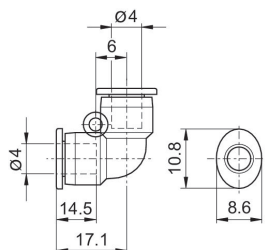

## 2121206000

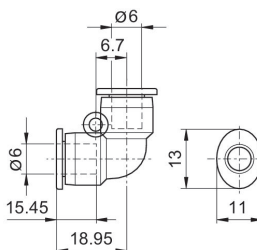

## 2121208000

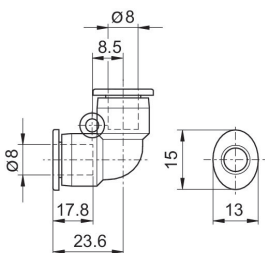

## 2121210000

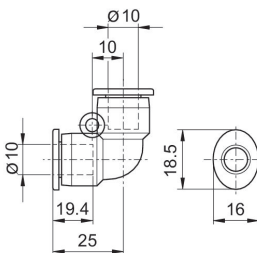



**2121212000**

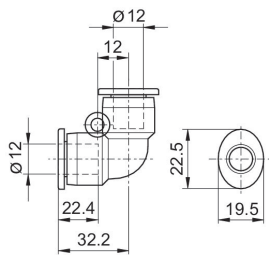

**2121214000**

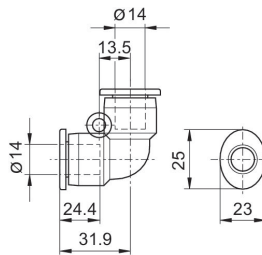

**R412005033**

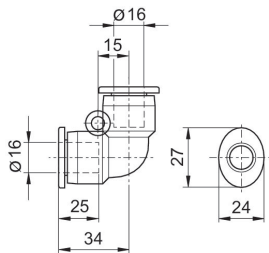

Série QR1-S-RVS Standard

Raccord passe-cloison angulaire  
Raccord instantané  
Raccord instantané



G	Ø D	Unité de livraison [Pcs.]	Référence
Ø 4	Ø 4	10	R412005056
Ø 6	Ø 6	10	R412005057
Ø 8	Ø 8	10	R412005375
Ø 10	Ø 10	10	R412005376

R412005056

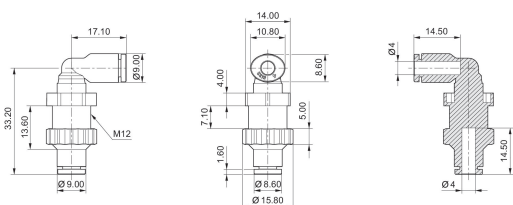

R412005057

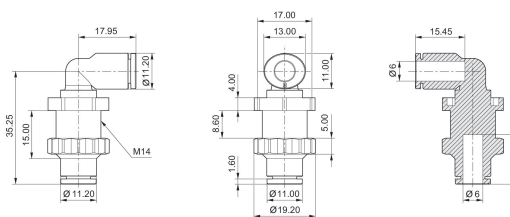

R412005375

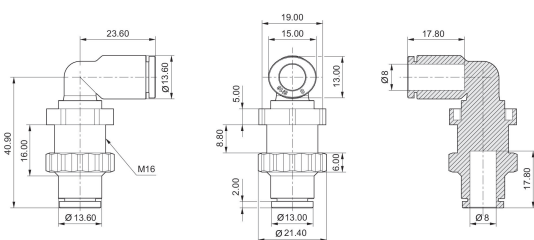

R412005376

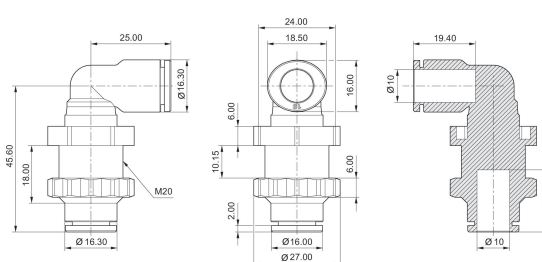

**Série QR1-S-RMT Standard**

Raccord enfichable, triple, réducteur  
Raccord instantané  
Raccord instantané



G	Ø D	Unité de livraison [Pcs.]	Référence
Ø 6	Ø 4	10	R412005346
Ø 8	Ø 4	10	R412005347
Ø 8	Ø 6	10	R412005348
Ø 10	Ø 6	10	R412005349
Ø 10	Ø 8	10	R412005350

**R412005346**

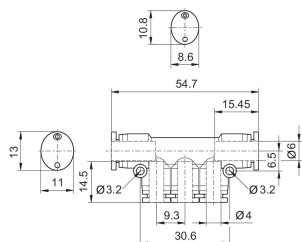

**R412005347**

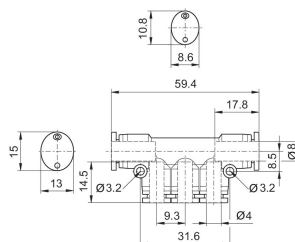

**R412005348**

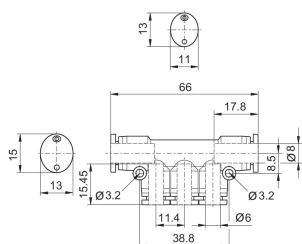

**R412005349**

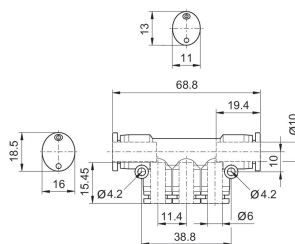

**R412005350**

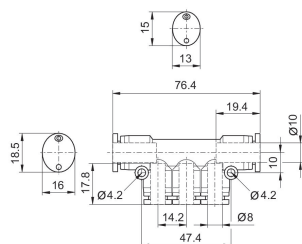

## Série QR1-S-RTK Standard

Raccord enfichable T  
Raccord instantané  
Raccord instantané



G	Ø D	Unité de livraison [Pcs.]	Référence
Ø 4	Ø 4	10	2121104000
Ø 6	Ø 6	10	2121106000
Ø 8	Ø 8	10	2121108000
Ø 10	Ø 10	10	2121110000
Ø 12	Ø 12	10	2121112000
Ø 14	Ø 14	5	2121114000
Ø 16	Ø 16	5	R412005025

## 2121104000

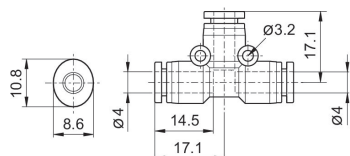

## 2121106000

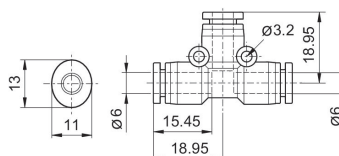

## 2121108000

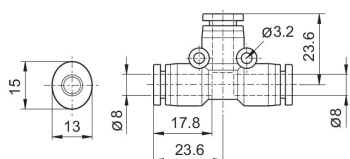

## 2121110000

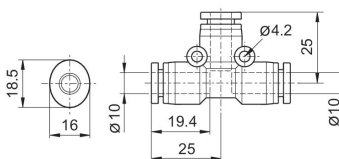

## 2121112000

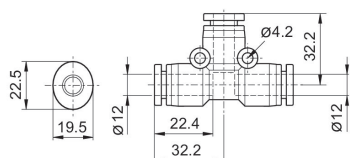

## 2121114000

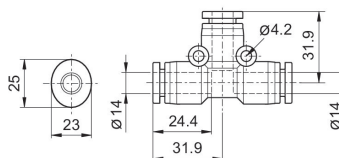

**R412005025**

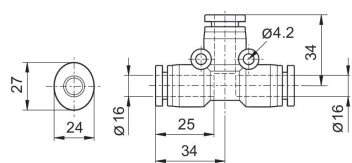

## Série QR1-S-RTR Standard

Raccord enfichable T, réducteur  
Raccord instantané  
Raccord instantané



G	Ø D	Unité de livraison [Pcs.]	Référence
Ø 6	Ø 4	10	R412005026
Ø 8	Ø 4	10	R412005027
Ø 8	Ø 6	10	R412005028
Ø 10	Ø 6	10	R412005029
Ø 10	M8	10	R412005030
Ø 12	Ø 8	10	R412005031
Ø 12	Ø 10	10	R412005032

## R412005026

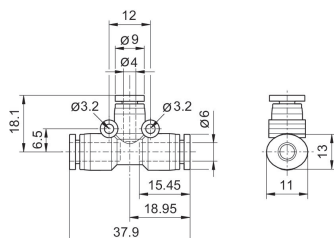

## R412005027

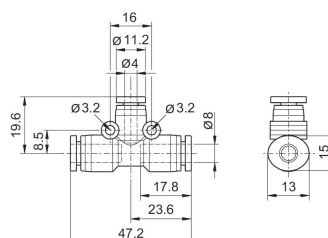

## R412005028

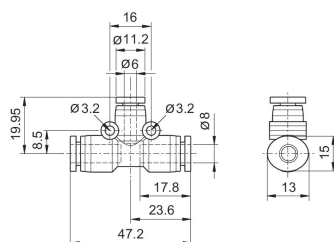

## R412005029

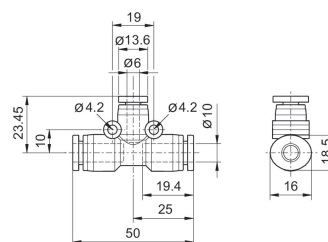

**R412005030**

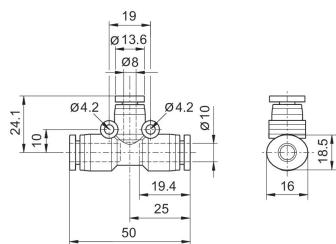

**R412005031**

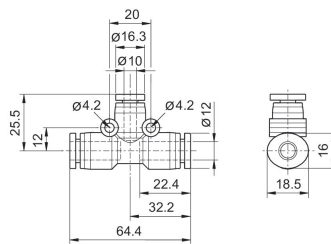

**R412005032**

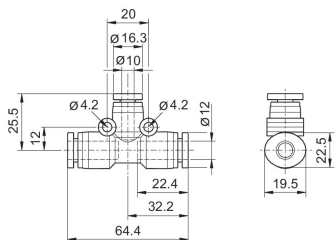

Série QR1-S-RYK Standard

Raccord enfichable Y  
Raccord instantané  
Raccord instantané

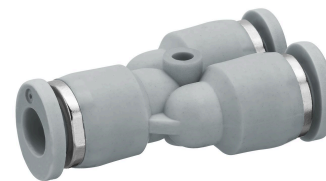

G	Ø D	Unité de livraison [Pcs.]	Référence
Ø 4	Ø 4	10	2121804000
Ø 6	Ø 6	10	2121806000
Ø 8	Ø 8	10	2121808000
Ø 10	Ø 10	10	2121810000
Ø 12	Ø 12	10	2121812000

2121804000

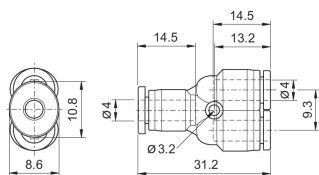

2121806000

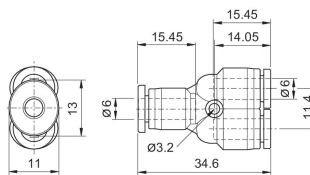

2121808000

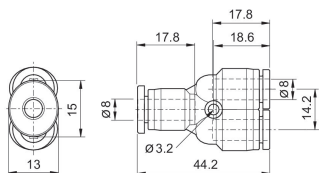

2121810000

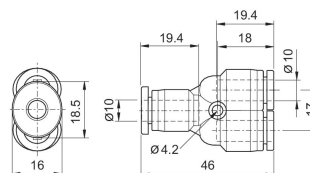

2121812000

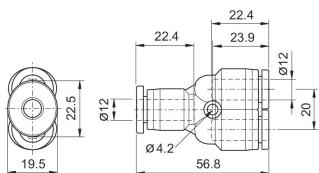



Série QR1-S-RYR Standard

Raccord enfichable Y, réducteur  
Raccord instantané  
Raccord instantané



G	Ø D	Unité de livraison [Pcs.]	Référence
Ø 6	Ø 4	10	2121806040
Ø 8	Ø 4	10	R412005081
Ø 8	Ø 6	10	2121808060
Ø 10	Ø 6	10	R412005082
Ø 10	Ø 8	10	2121810080
Ø 12	Ø 8	10	R412005083
Ø 12	Ø 10	10	R412005080

2121806040

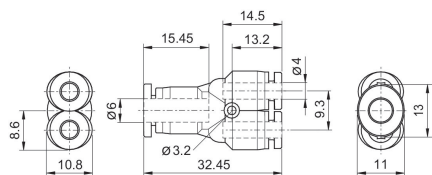

R412005081

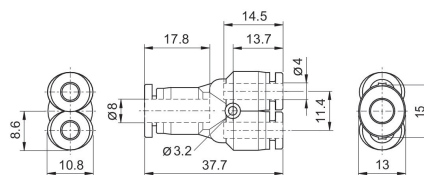

2121808060

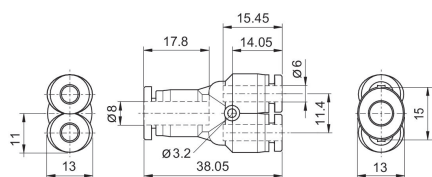

R412005082

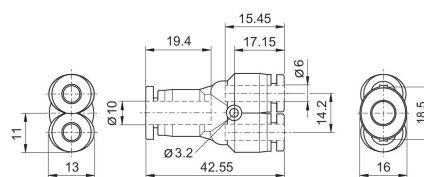

2121810080

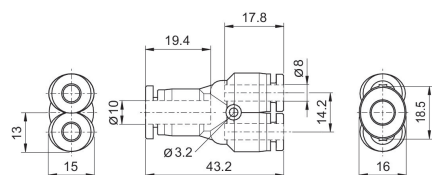

R412005083

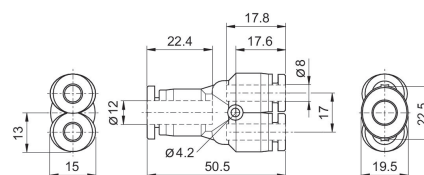

R412005080

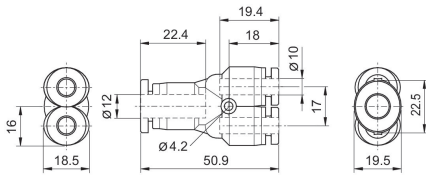

**Série QR1-S-RYD Standard**

Raccord enfichable Y, réducteur double  
Raccord instantané

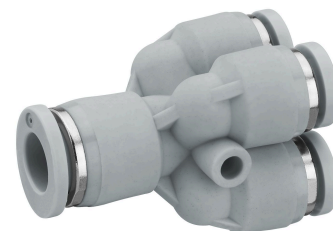

G	Ø D	Unité de livraison [Pcs.]	Référence
Ø 6	Ø 4	10	R412005344
Ø 8	Ø 6	10	R412005345

**R412005344**

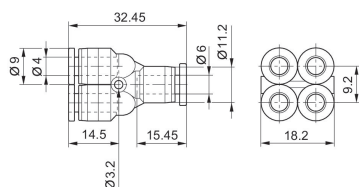

**R412005345**

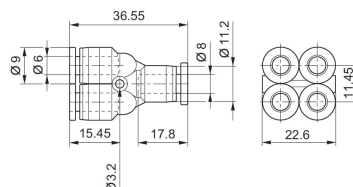

Série QR1-S-RXS Standard

Raccord enfichable X  
Raccord instantané  
Raccord instantané



G	Ø D	Unité de livraison [Pcs.]	Référence
Ø 4	Ø 4	10	R412005361
Ø 6	Ø 6	10	R412005362
Ø 8	Ø 8	10	R412005363
Ø 10	Ø 10	10	R412005364

R412005361

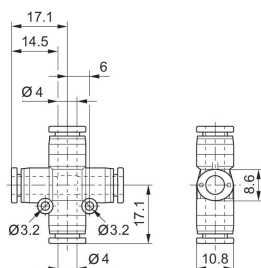

R412005362

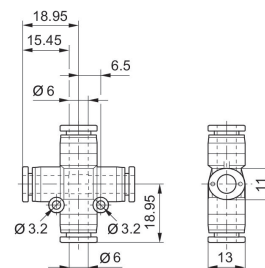

R412005363

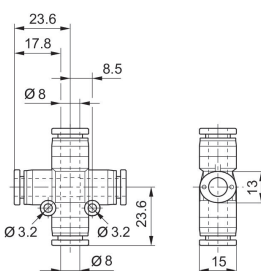

R412005364

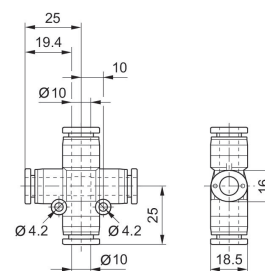

## Série QR1-S-RED Standard

Raccord instantané droit, réducteur  
Raccord instantané  
Prise femelle

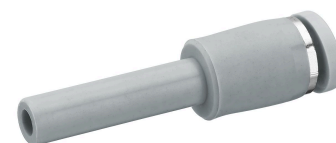

G	Ø D	Unité de livraison [Pcs.]	Référence
Ø 4	Ø 6	10	2121706040
Ø 4	Ø 8	10	2121708040
Ø 4	Ø 10	10	2121710040
Ø 6	Ø 8	10	2121708060
Ø 6	Ø 10	10	2121710060
Ø 6	Ø 12	10	2121712060
Ø 8	Ø 10	10	2121710080
Ø 8	Ø 12	10	2121712080
Ø 8	Ø 14	10	2121714080
Ø 10	Ø 12	10	2121712100
Ø 10	Ø 14	10	2121714100
Ø 12	Ø 14	10	2121714120

## 2121706040

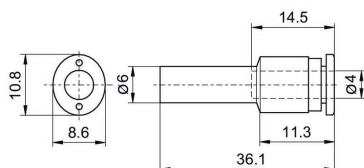

## 2121708040

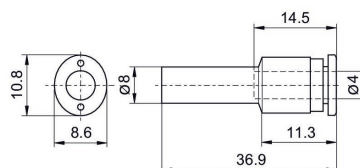

## 2121710040

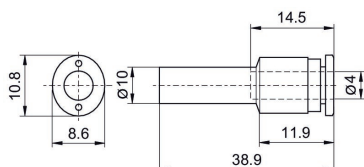

## 2121708060

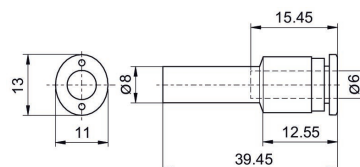

**2121710060**

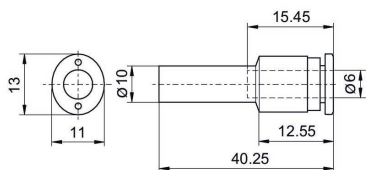

**2121712060**

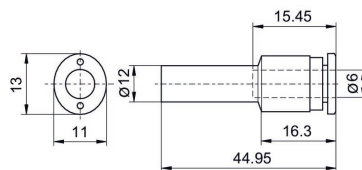

**2121710080**

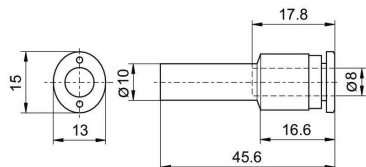

**2121712080**

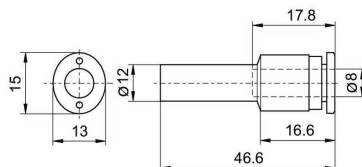

**2121714080**

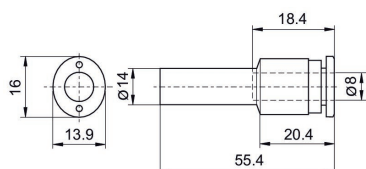

**2121712100**

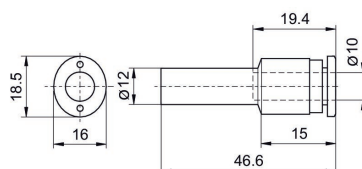

**2121714100**

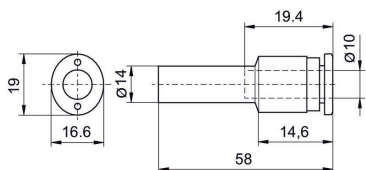

**2121714120**

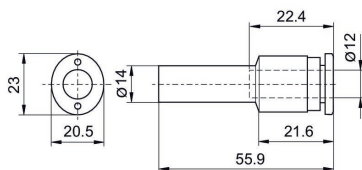

## Série QR1-S-RVA Standard

Raccord instantané angulaire  
Prise femelle  
Raccord instantané

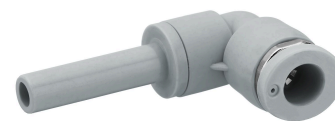

G	Ø D	Unité de livraison [Pcs.]	Référence
Ø 4	Ø 4	10	2121304040
Ø 6	Ø 6	10	2121306060
Ø 8	Ø 8	10	2121308080
Ø 10	Ø 10	10	2121310100
Ø 12	Ø 12	10	R412005036

## 2121304040

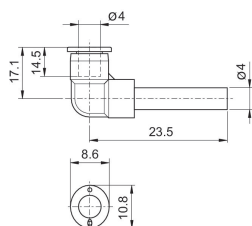

## 2121306060

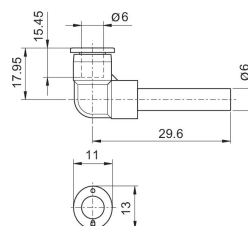

## 2121308080

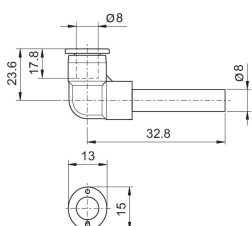

## 2121310100

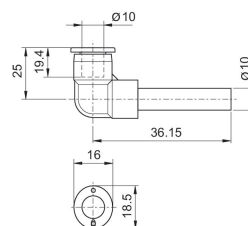

## R412005036

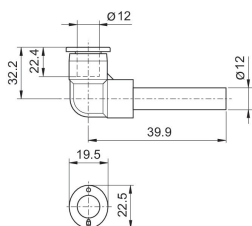

## Série QR1-S-RLL Standard

Raccord instantané angulaire  
Prise femelle longue  
Raccord instantané



G	Ø D	Unité de livraison [Pcs.]	Référence
Ø 4	Ø 4	10	R412005039
Ø 6	Ø 6	10	R412005040
Ø 8	Ø 8	10	R412005041
Ø 10	Ø 10	10	R412005042
Ø 12	Ø 12	10	R412005043

## R412005039

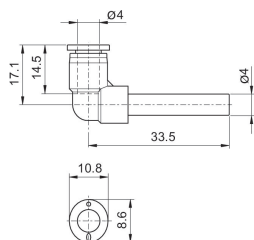

## R412005040

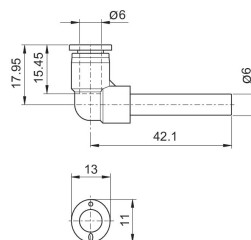

## R412005041

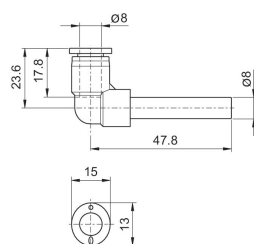

## R412005042

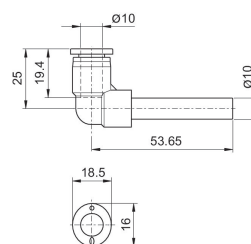

## R412005043

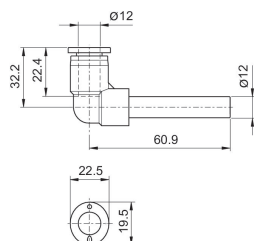



## Série QR1-S-RVR Standard

Raccord instantané angulaire  
Raccord instantané réducteur  
Prise femelle



G	Ø D	Unité de livraison [Pcs.]	Référence
Ø 4	Ø 6	10	2121304060
Ø 6	Ø 8	10	2121306080
Ø 8	Ø 10	10	R412005034

## 2121304060

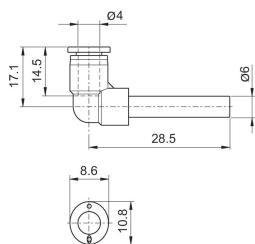

## 2121306080

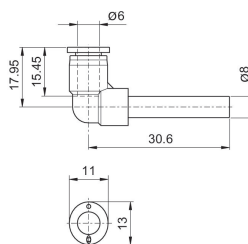

## R412005034

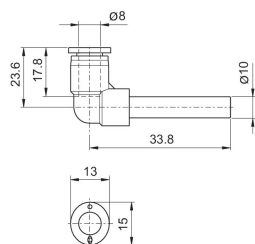

## Série QR1-S-RTC Standard

Raccord instantané T  
Prise femelle  
Raccord instantané

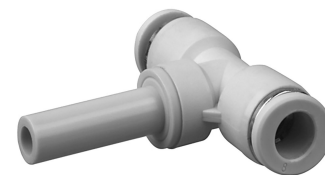

G	Ø D	Unité de livraison [Pcs.]	Référence
Ø 6	Ø 6	10	2122706000
Ø 8	Ø 8	10	2122708000
Ø 12	Ø 12	10	R412010596

## 2122706000

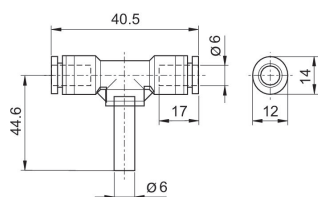

## 2122708000

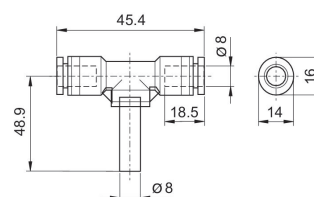

## R412010596

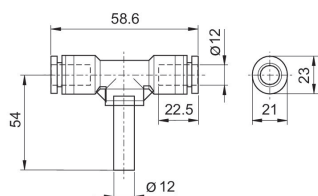

Série QR1-S-RY2 Standard

Raccord instantané Y  
Prise femelle  
Raccord instantané



G	Ø D	Unité de livraison [Pcs.]	Référence
Ø 4	Ø 4	10	R412005332
Ø 6	Ø 6	10	R412005333
Ø 8	Ø 8	10	R412005334
Ø 10	Ø 10	10	R412005335
Ø 12	Ø 12	10	R412005336

R412005332

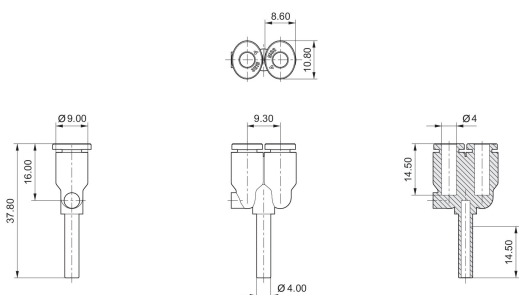

R412005333

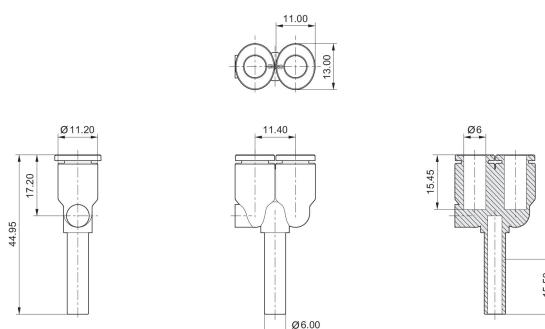

R412005334

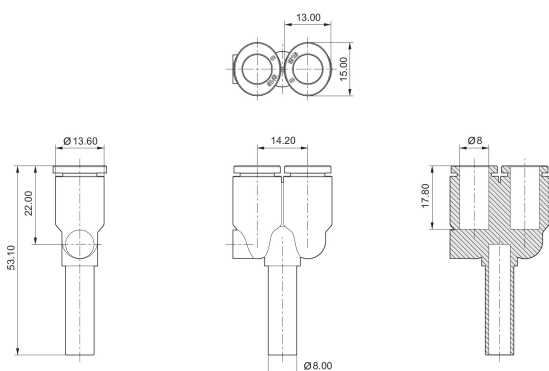

R412005335

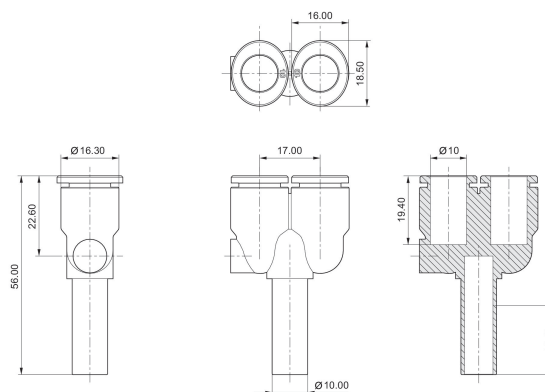

R412005336

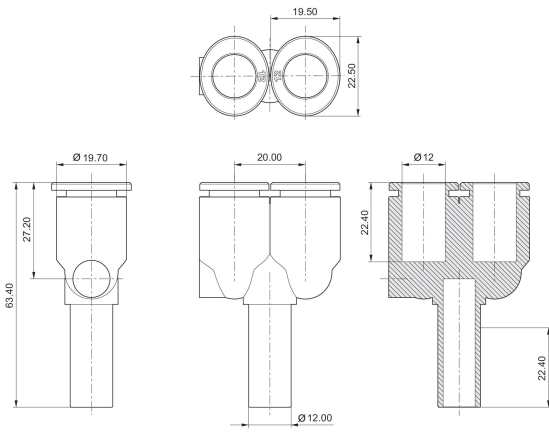

Série QR1-S-R2R Standard

Raccord instantané Y, réducteur  
Raccord instantané  
Prise femelle

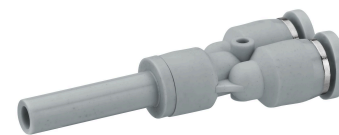

G	Ø D	Unité de livraison [Pcs.]	Référence
Ø 4	Ø 6	10	R412005337
Ø 6	Ø 8	10	R412005338
Ø 8	Ø 10	10	R412005339
Ø 10	Ø 12	10	R412005340

R412005337

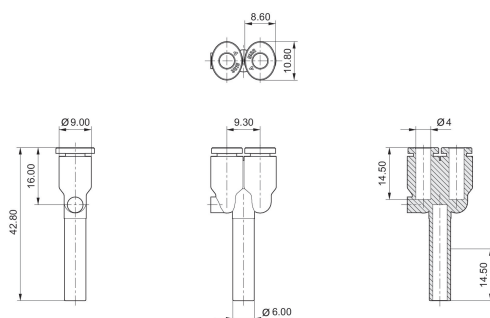

R412005338

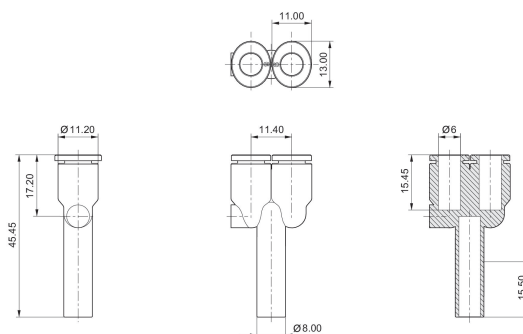

R412005339

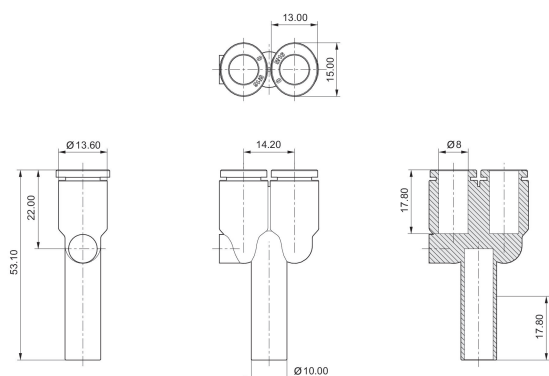

R412005340

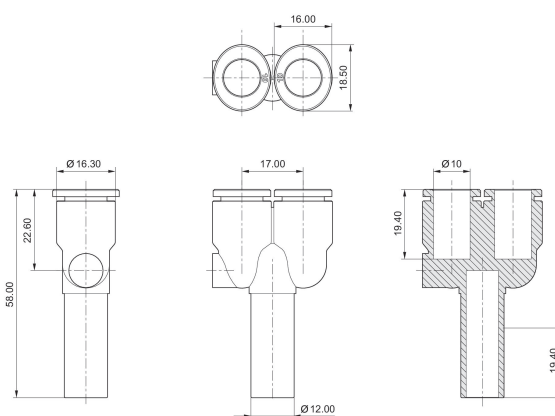

**Série QR1-S-RY4 Standard**

Raccord instantané Y, réducteur  
Prise femelle  
Raccord instantané

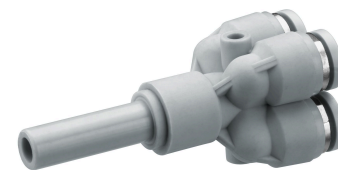

G	Ø D	Unité de livraison [Pcs.]	Référence
Ø 4	Ø 6	10	R412005341
Ø 4	Ø 8	10	R412005342

**R412005341**

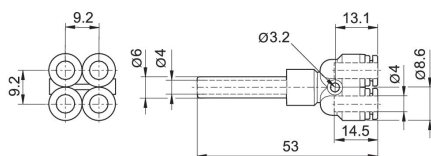

**R412005342**

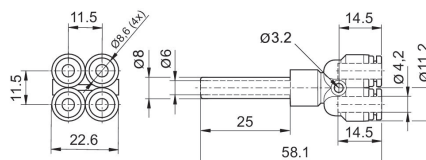

## Série QR1-S-RCA Standard

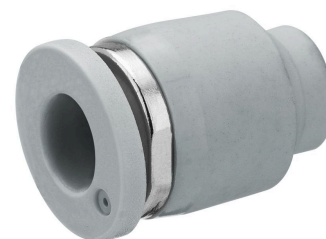
Bouchon d'étanchéification  
Raccord instantané

G	Unité de livraison [Pcs.]	Référence
Ø 4	20	R412005111
Ø 6	20	R412005112
Ø 8	20	R412005113
Ø 10	20	R412005114
Ø 12	20	R412005115

## R412005111

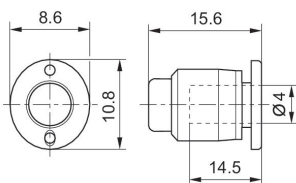

## R412005112

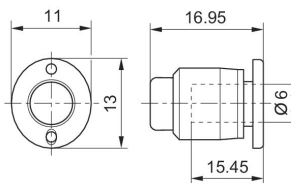

## R412005113

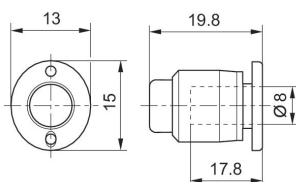

## R412005114

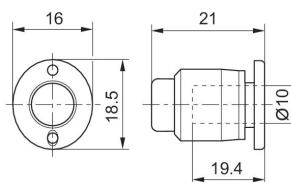

## R412005115

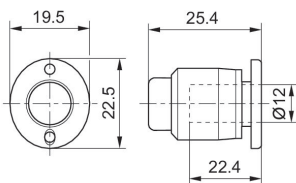

## Série QR1-S-RBS Standard

Prise de verrouillage  
Prise femelle

G	Unité de livraison [Pcs.]	Référence
Ø 4	20	2123204000
Ø 6	20	2123206000
Ø 8	20	2123208000
Ø 10	20	2123210000
Ø 12	20	2123212000
Ø 14	10	2123214000
Ø16	10	R412005331

## Dimensions

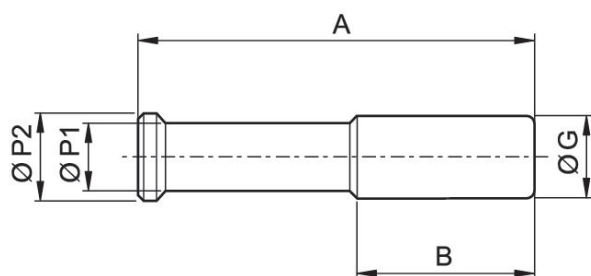

Référence	Orifice G	A	B	Ø P1	Ø P2
2123204000		28	16	3	4
2123206000		32	17	4	6
2123208000		39	21,5	5	9
2123210000		42	21	8	10
2123212000		44	30	8	12
2123214000		45	24.6	8	14
R412005331		46	24.8	10	16



## Série QR1-S-RDS Standard

Raccord  
Prise femelle  
Prise femelle

G	Ø D	Unité de livraison [Pcs.]	Référence
Ø 4	Ø 4	10	2123104000
Ø 6	Ø 6	10	2123106000
Ø 8	Ø 8	10	2123108000
Ø 10	Ø 10	10	2123110000
Ø 12	Ø 12	10	2123112000

## Dimensions

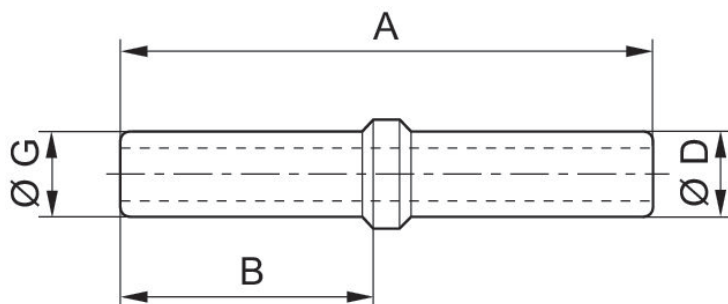

Référence	Orifice D	Orifice G	A	B
2123104000			37,5	17,8
2123106000			39,7	18,7
2123108000			43,4	20,7
2123110000			47,2	22,6
2123112000			53	25,5
2123114000			53	-
R412005322			54	24,8

## Série QR1-S-RDR Standard

Raccord, réducteur  
Prise femelle  
Prise femelle

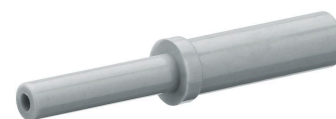

G	Ø D	Unité de livraison [Pcs.]	Référence
Ø 6	Ø 4	10	R412005323
Ø 8	Ø 4	10	R412005324
Ø 8	Ø 6	10	R412005325
Ø 10	Ø 6	10	R412005326
Ø 10	Ø 8	10	R412005327
Ø 12	Ø 8	10	R412005328
Ø 12	Ø 10	10	R412005329

## R412005323

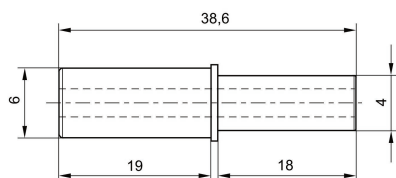

## R412005324

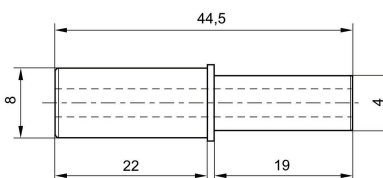

## R412005325

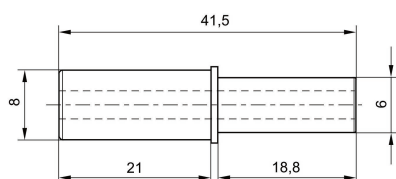

## R412005326

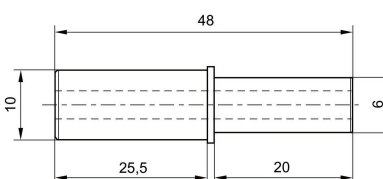

## R412005327

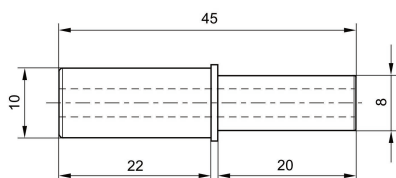

## R412005328

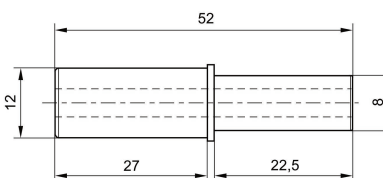

R412005329

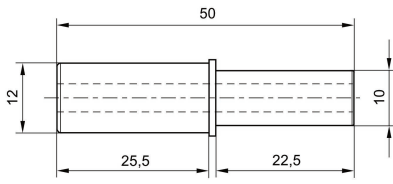

## Série QR1-S-M2R Mini

Raccord instantané Y, réducteur  
Prise femelle  
Raccord instantané

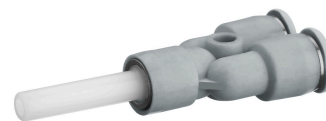

G	Ø D	Unité de livraison [Pcs.]	Référence
Ø 4	Ø 3	25	R412005445
Ø 6	Ø 4	25	R412005446

## Dimensions

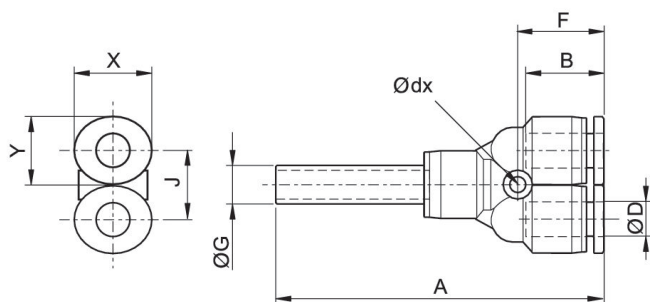

Référence	Orifice D	Orifice G	Ø dx	A	B	F	J	X	Y
R412005445	Ø 3	Ø 4	3.2	33	9.5	13.4	8	7	6
R412005446	Ø 4	Ø 6	3.2	38.5	11.5	13.6	10.5	10	8

## Série QR1-S-MAN Mini

Raccord droit hexagonal mâle  
Filetage  
Raccord instantané

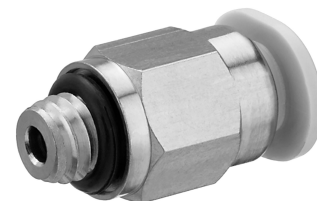

G	Ø D	Unité de livraison [Pcs.]	Référence
M3	Ø 3	25	R412005116
M3	Ø 4	25	R412005117
M5	Ø 3	25	R412005118
M5	Ø 4	25	R412005119
M5	Ø 6	25	R412005120
M6	Ø 3	25	R412005121
M6	Ø 4	25	R412005122
M6	Ø 6	25	R412005123
G 1/8	Ø 4	25	R412005124
G 1/8	Ø 6	25	R412005125

## Dimensions

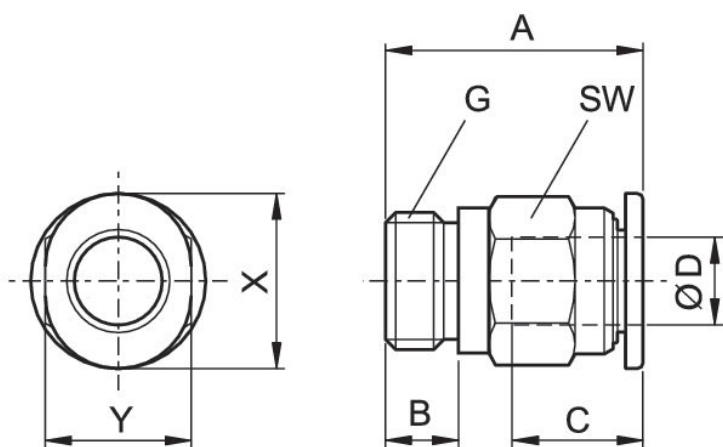

Référence	Orifice D	Orifice G	A	B	C	SW	X	Y
R412005116	Ø 3	M3	13.6	3	9.5	6	7	6
R412005117	Ø 4	M3	17.2	3	11.5	8	10	8
R412005118	Ø 3	M5	16.2	4	9.5	8	7	6
R412005119	Ø 4	M5	16.2	4	11.5	8	10	8

Référence	Orifice D	Orifice G	A	B	C	SW	X	Y
R412005120	Ø 6	M5	17.3	4 M3	12.5	10	12	10
R412005121	Ø 3	M6	17	5	9.5	8	7	6
R412005122	Ø 4	M6	17.4	5	11.5	8	10	8
R412005123	Ø 6	M6	18.3	5	12.5	10	12	10
R412005124	Ø 4	G 1/8	12.7	5	11.5	10	10	8
R412005125	Ø 6	G 1/8	14.9	5	12.5	10	12	10

## Série QR1-S-MBS Mini

Prise de verrouillage  
Prise femelle

G	Unité de livraison [Pcs.]	Référence
Ø 3	25	R412005447

## Dimensions

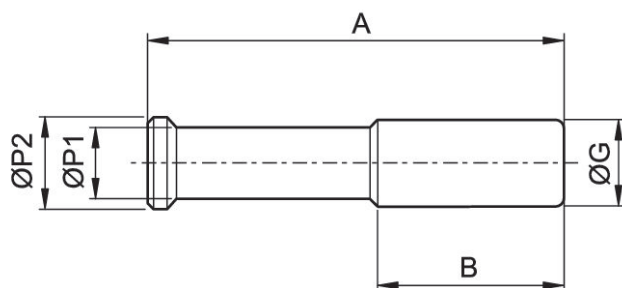

Référence	Orifice G	A	B	Ø P1	Ø P2
R412005447	Ø 3	22	9.5	3	4

## Série QR1-S-MED Mini

Raccord instantané droit, réducteur  
Prise femelle  
Raccord instantané



G	Ø D	Unité de livraison [Pcs.]	Référence
Ø 4	Ø 3	25	R412005437
Ø 6	Ø 4	25	R412005438

## Dimensions

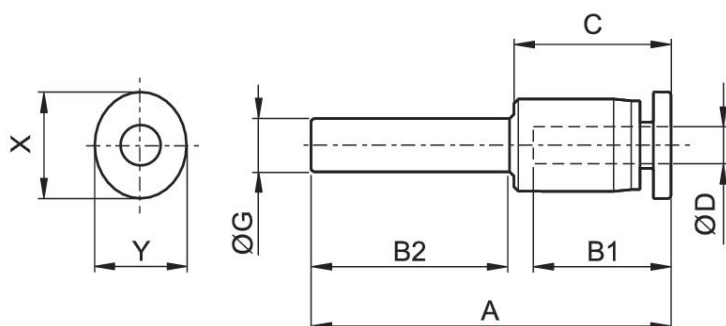

Référence	Orifice D	Orifice G	A	B1	B2	C	X	Y
R412005437	Ø 3	Ø 4	29.2	9.5	11.5	11.2	7	6
R412005438	Ø 4	Ø 6	33.2	11.5	12.5	13.2	10	8



## Série QR1-S-MIN Mini

Raccord droit à six pans creux  
Filetage  
Raccord instantané



G	Ø D	Unité de livraison [Pcs.]	Référence
M3	Ø 3	25	R412005264
M3	Ø 4	25	R412005265
M5	Ø 3	25	R412005266
M5	Ø 4	25	R412005267
M5	Ø 6	25	R412005268
M6	Ø 3	25	R412005269
M6	Ø 4	25	R412005270
M6	Ø 6	25	R412005271
M7	Ø 4	25	R412005272
M7	Ø 6	25	R412005273
G 1/8	Ø 4	25	R412005274
G 1/8	Ø 6	25	R412005275

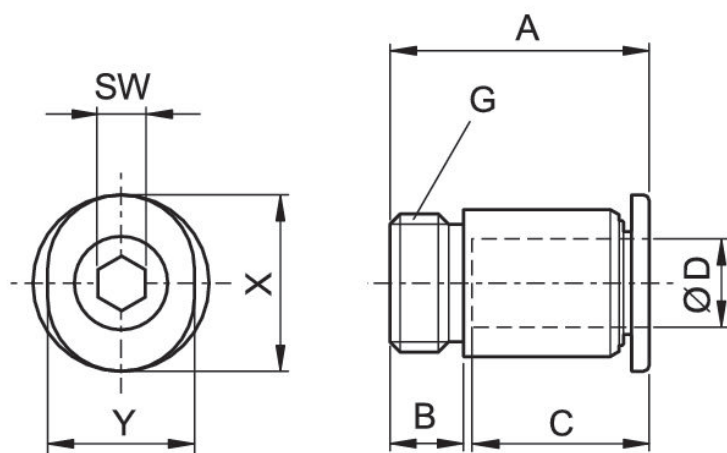

Référence	Orifice D	Orifice G	A	B	C	SW	X	Y
R412005264	Ø 3	M3	15.9	3	9.5	1.5	7	6
R412005265	Ø 4	M3	18	3	11.5	1.5	10	8
R412005266	Ø 3	M5	18	4	9.5	2	7	6

Référence	Orifice D	Orifice G	A	B	C	SW	X	Y
R412005267	Ø 4	M5	16.3	4	11.5	2.5	10	8
R412005268	Ø 6	M5	17.8	4	12.5	2.5	12	10
R412005269	Ø 3	M6	20.2	5	9.5	3	7	6
R412005270	Ø 4	M6	20.2	5	11.5	3	10	8
R412005271	Ø 6	M6	18.8	5	12.5	3	12	10
R412005272	Ø 4	M7	21.4	5	11.5	3	10	8
R412005273	Ø 6	M7	20.1	5	12.5	3	12	10
R412005274	Ø 4	G 1/8	17	5	11.5	3	10	8
R412005275	Ø 6	G 1/8	20.6	5	12.5	4	12	10

## Série QR1-S-MLT Mini

Vissage en L  
Filetage  
Raccord instantané

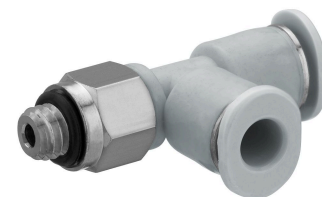

G	Ø D	Unité de livraison [Pcs.]	Référence
M5	Ø 4	25	R412005405
M5	Ø 6	25	R412005406
G 1/8	Ø 4	25	R412005410
G 1/8	Ø 6	25	R412005411

## Dimensions

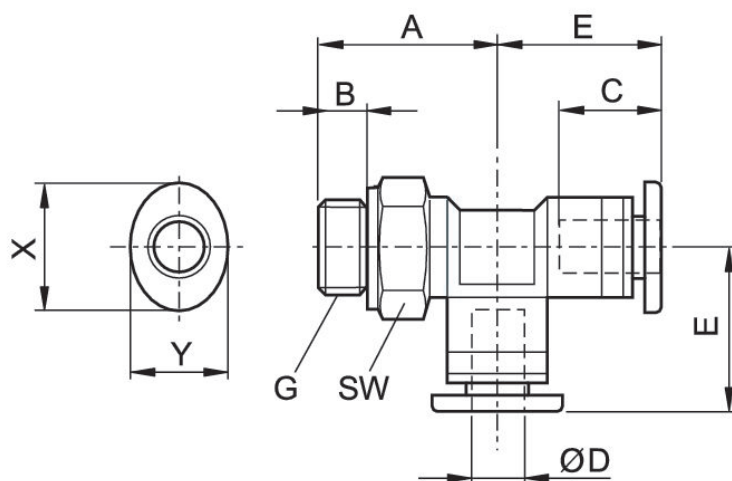

Référence	Orifice D	Orifice G	A	B	C	E	SW	X	Y
R412005405	Ø 4	M5	15	4	11.5	13.1	8	10	8
R412005406	Ø 6	M5	17	4	12.5	14.4	8	12	10
R412005410	Ø 4	G 1/8	13.4	5	11.5	13.1	10	10	8
R412005411	Ø 6	G 1/8	15	5	12.5	14.4	10	12	10

## Série QR1-S-MSK Mini

Raccord enfichable droit  
Raccord instantané  
Raccord instantané



G	Ø D	Unité de livraison [Pcs.]	Référence
Ø 3	Ø 3	25	R412005412
Ø 4	Ø 4	25	R412005413
Ø 6	Ø 6	25	R412005414

## Dimensions

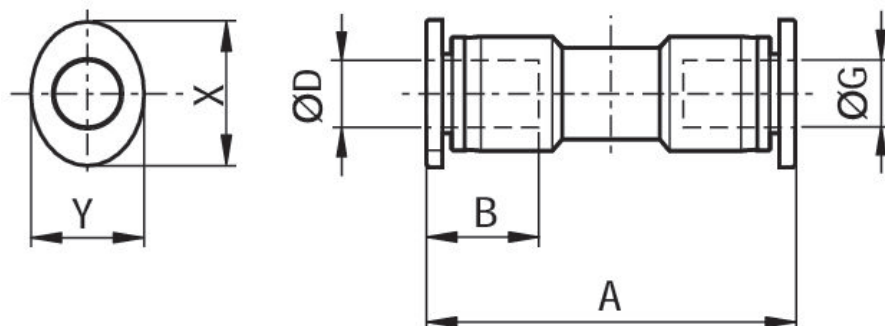

Référence	Orifice D	Orifice G	A	B	X	Y
R412005412	Ø 3	Ø 3	20.4	9.5	7	6
R412005413	Ø 4	Ø 4	23.8	11.5	10	8
R412005414	Ø 6	Ø 6	25.1	12.5	12	10

## Série QR1-S-MSM Mini

Raccord instantané Schott en métal

Raccord instantané

Raccord instantané



G	Ø D	Unité de livraison [Pcs.]	Référence
Ø 4	Ø 4	25	R412005418
Ø 6	Ø 6	25	R412005419

## Dimensions

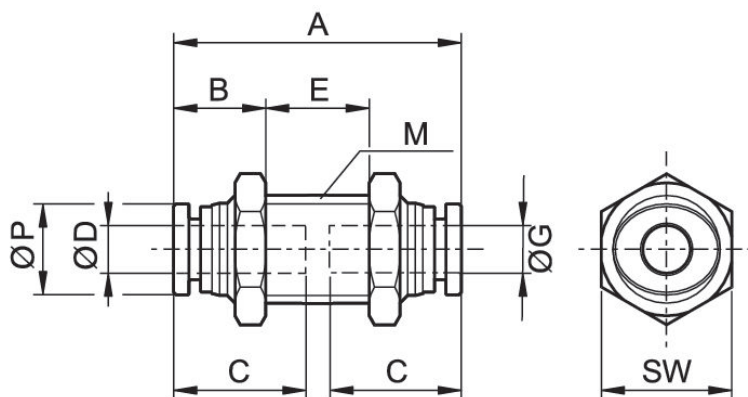

Référence	Orifice D	Orifice G	M	A	B	C	E	SW	Ø P
R412005418	Ø 4	Ø 4	M10x1,0	24	9	11.5	7.5	12	8
R412005419	Ø 6	Ø 6	M12x1,0	25.9	10.5	12.5	6	14	10.5

## Série QR1-S-MSR Mini

Raccord enfichable droit, réducteur

Raccord instantané

Raccord instantané



G	Ø D	Unité de livraison [Pcs.]	Référence
Ø 4	Ø 3	25	R412005415
Ø 6	Ø 4	25	R412005416

## Dimensions

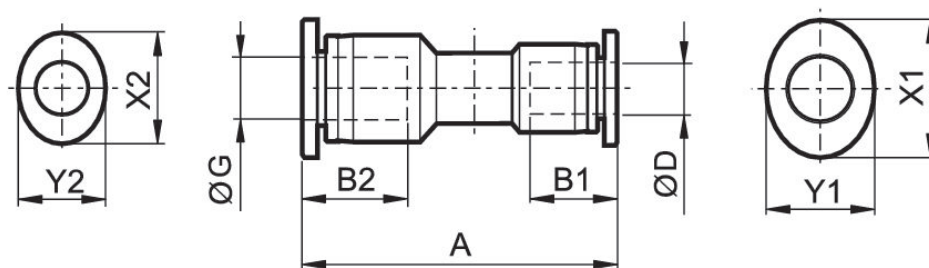

Référence	Orifice D	Orifice G	A	B1	B2	X1	X2	Y1	Y2
R412005415	Ø 3	Ø 4	22.5	9.5	11.5	7	10	6	8
R412005416	Ø 4	Ø 6	24	11.5	12.5	10	12	8	10

## Série QR1-S-MTK Mini

Raccord enfichable T  
Raccord instantané  
Raccord instantané



G	Ø D	Unité de livraison [Pcs.]	Référence
Ø 3	Ø 3	25	R412005426
Ø 4	Ø 4	25	R412005427
Ø 6	Ø 6	25	R412005428

## Dimensions

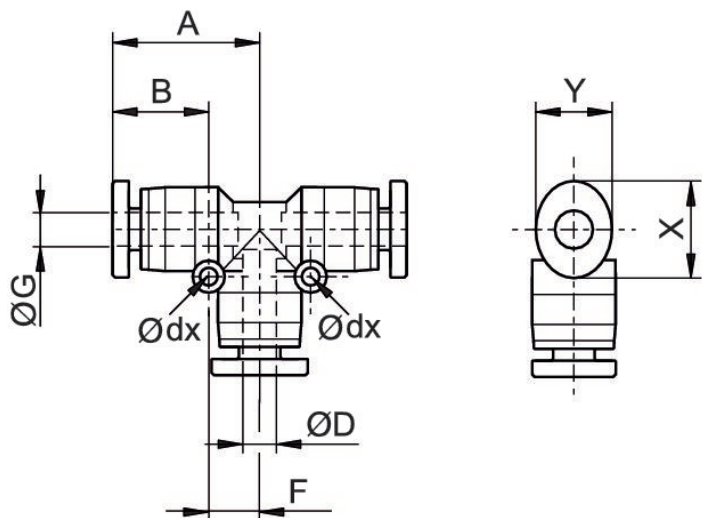

Référence	Orifice D	Orifice G	Ø dx	A	B	F	X	Y
R412005426	Ø 3	Ø 3	3.2	11.4	9.5	4.5	7	6
R412005427	Ø 4	Ø 4	3.2	13.9	11.5	5.8	10	8
R412005428	Ø 6	Ø 6	3.2	15.4	12.5	6.5	12	10

## Série QR1-S-MTT Mini

Raccord T  
Filetage  
Raccord instantané

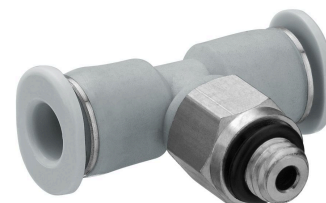

G	Ø D	Unité de livraison [Pcs.]	Référence
M5	Ø 4	25	R412005395
M5	Ø 6	25	R412005396
G 1/8	Ø 4	25	R412005400
G 1/8	Ø 6	25	R412005401

## Dimensions

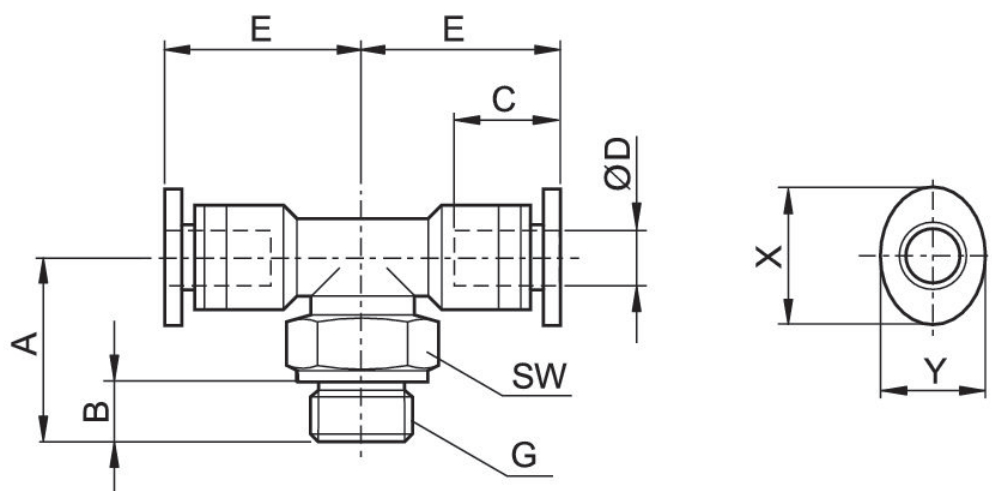

Référence	Orifice D	Orifice G	A	B	C	E	SW	X	Y
R412005395	Ø 4 M5 M5	M5	15	4	11.5	13.1	8	10	8
R412005396	Ø 6	M5	16	4	12.5	14.4	8	12	10
R412005400	Ø 4	G 1/8	13.4	5	11.5	13.1	12	10	8
R412005401	Ø 6	G 1/8	14.4	5	12.5	14.4	10	12	10



## Série QR1-S-MVA Mini

Raccord instantané angulaire  
Prise femelle  
Raccord instantané



G	Ø D	Unité de livraison [Pcs.]	Référence
Ø 3	Ø 3	25	R412005439
Ø 4	Ø 4	25	R412005440
Ø 6	Ø 6	25	R412005441

## Dimensions

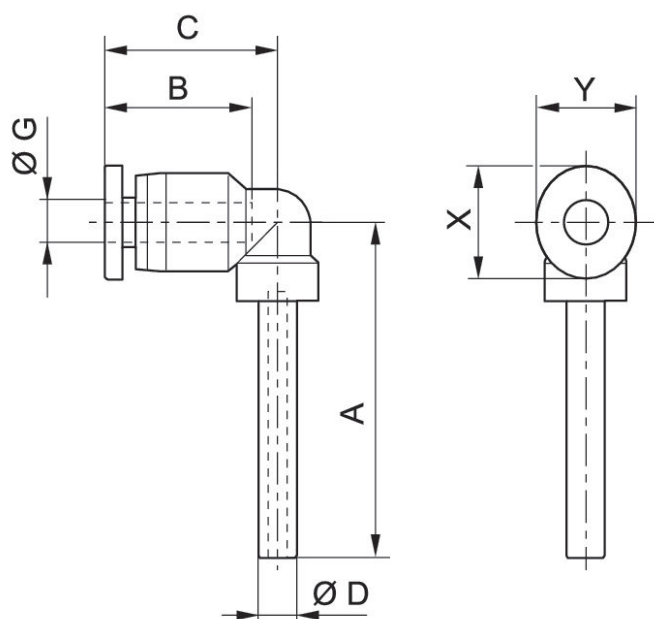

Référence	Orifice D	Orifice G	A	B	C	X	Y
R412005439	Ø 3	Ø 3	21.6	9.5	11.2	7	6
R412005440	Ø 4	Ø 4	27.6	11.5	15.6	10	8
R412005441	Ø 6	Ø 6	29.6	12.5	16.9	12	10

## Série QR1-S-MVK Mini

Raccord d'angle enfichable  
Raccord instantané  
Raccord instantané



G	Ø D	Unité de livraison [Pcs.]	Référence
Ø 3	Ø 3	25	R412005423
Ø 4	Ø 4	25	R412005424
Ø 6	Ø 6	25	R412005425

## Dimensions

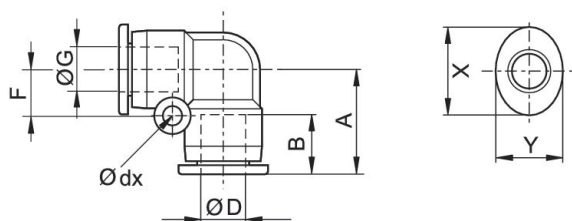

Référence	Orifice D	Orifice G	Ø dx	A	B	F	X	Y
R412005423	Ø 3	Ø 3	3.2	11.4	9.5	4.5	7	6
R412005424	Ø 4	Ø 4	3.2	13.9	11.5	5.8	10	8
R412005425	Ø 6	Ø 6	3.2	15.4	12.5	6.5	12	10

## Série QR1-S-MVL Mini

Raccord d'angle long  
Filetage  
Raccord instantané



G		Ø D	Unité de livraison [Pcs.]	Référence
M3		Ø 3	25	R412005381
M3		Ø 4	25	R412005382
M5		Ø 4	25	R412005384
M5		Ø 6	25	R412005385
G 1/8		Ø 4	25	R412005390
G 1/8		Ø 6	25	R412005391

## Dimensions

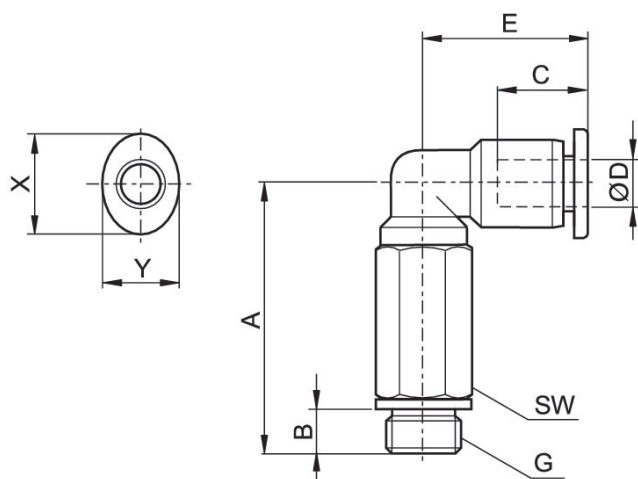

Référence	Orifice D	Orifice G	A	B	C	E	SW	X	Y
R412005381	Ø 3	M3	19.4	3	9.5	11.2	6	7	6
R412005382	Ø 4	M3	23	3	11.5	15.6	8	10	8
R412005384	Ø 4	M5	26	4	11.5	15.6	8	10	8
R412005385	Ø 6	M5	26	4	12.5	16.9	8	12	10
R412005390	Ø 4	G 1/8	25.1	5	11.5	15.6	10	10	8
R412005391	Ø 6	G 1/8	26.4	5	12.5	16.9	10	12	10

## Série QR1-S-MVS Mini

Raccord passe-cloison angulaire  
Raccord instantané  
Raccord instantané



G	Ø D	Unité de livraison [Pcs.]	Référence
Ø 4	Ø 4	25	R412005421
Ø 6	Ø 6	25	R412005422

## Dimensions

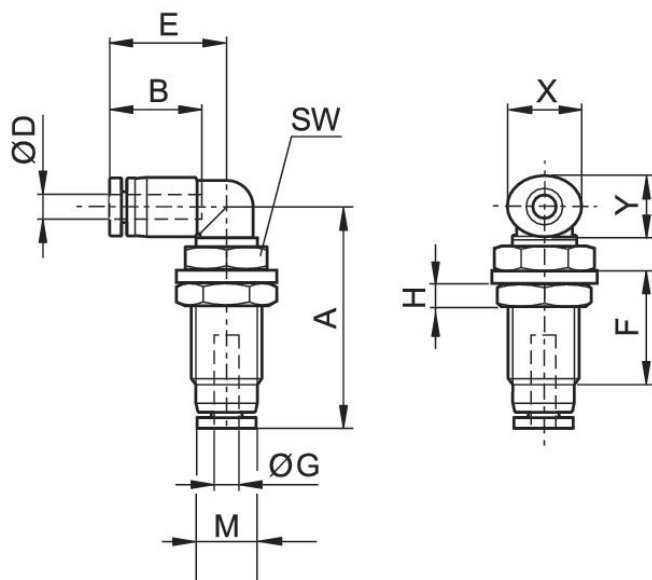

Référence	Orifice D	Orifice G	M	A	B	E	F	H	SW	X
R412005421	Ø 4	Ø 4	M10x1,0	24.4	11.5	15.3	13	3	12	10
R412005422	Ø 6	Ø 6	M12x1,0	31.5	12.5	16.3	16.6	4	14	12

Référence	Y
R412005421	8
R412005422	10

## Série QR1-S-MVT Mini

Raccord d'angle  
Filetage  
Raccord instantané

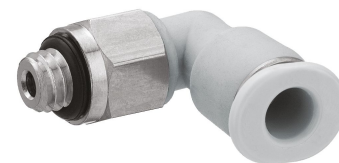

G		Ø D	Unité de livraison [Pcs.]	Référence
M3		Ø 3	25	R412005284
M3		Ø 4	25	R412005285
M5		Ø 3	25	R412005286
M5		Ø 4	25	R412005287
M5		Ø 6	25	R412005288
M6		Ø 3	25	R412005289
M6		Ø 6	25	R412005627
M6		Ø 4	25	R412005628
M7		Ø 4	25	R412005377
M7		Ø 6	25	R412005378
G 1/8		Ø 4	25	R412005379
G 1/8		Ø 6	25	R412005380

## Dimensions

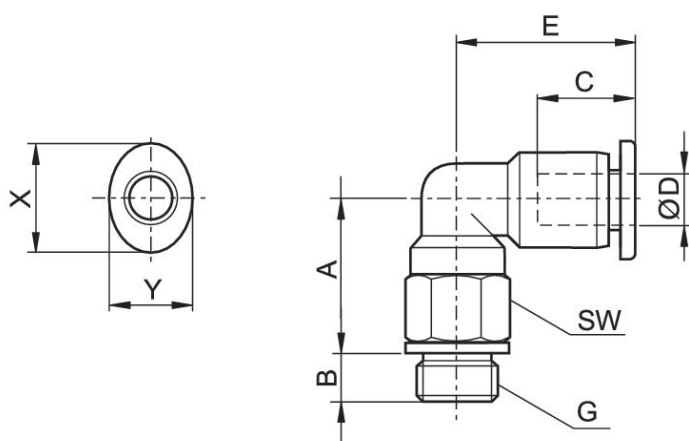

Référence	Orifice D	Orifice G	A	B	C	E	SW	X	Y
R412005284	Ø 3	M3	10.4	3	9.5	11.2	6	7	6
R412005285	Ø 4	M3	12	3	11.5	15.6	8	10	8
R412005286	Ø 3	M5	11.3	3.5	9.5	11.2	8	7	6

Référence	Orifice D	Orifice G	A	B	C	E	SW	X	Y
R412005287	Ø 4	M5	11.6	3.5	11.5	15.6	8	10	8
R412005288	Ø 6	M5	12.9	3.5	12.5	16.9	8	12	10
R412005289	Ø 3	M6	11.9	4.5	9.5	11.2	8	7	6
R412005628	Ø 4	M6	11.6	4.5	12.5	15.6	8	12	10
R412005627	Ø 6	M6	12.9	4.5	11.5	16.9	10	10	8
R412005377	Ø 4	M7	13.7	5.5	11.5	15.6	8	10	8
R412005378	Ø 6	M7	15	5.5	12.5	16.9	8	12	10
R412005379	Ø 4	G 1/8	12.6	5	11.5	15.6	12	10	8
R412005380	Ø 6	G 1/8	17	5	12.5	16.9	10	12	10

## Série QR1-S-MXS Mini

Raccord enfichable X  
Raccord instantané  
Raccord instantané



G	Ø D	Unité de livraison [Pcs.]	Référence
Ø 4	Ø 4	25	R412005435
Ø 6	Ø 6	25	R412005436

## Dimensions

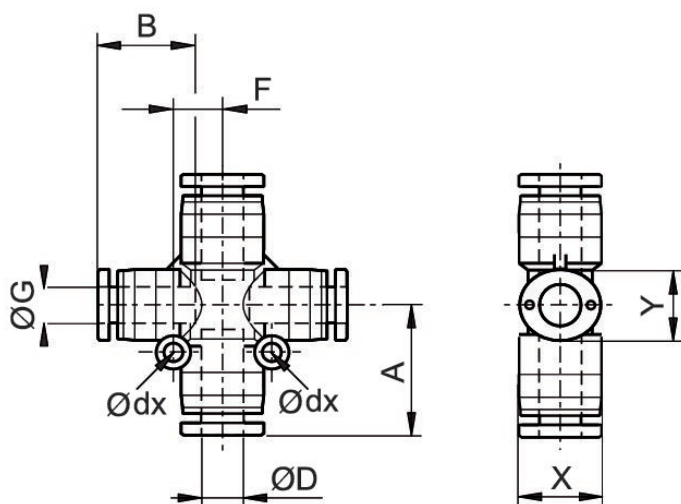

Référence	Orifice D	Orifice G	Ø dx	A	B	F	X	Y
R412005435	Ø 4	Ø 4	3.2	13.6	11.5	5.5	10	8
R412005436	Ø 6	Ø 6	3.2	15.9	12.5	6.5	12	10

## Série QR1-S-MYK Mini

Raccord enfichable Y  
Raccord instantané  
Raccord instantané

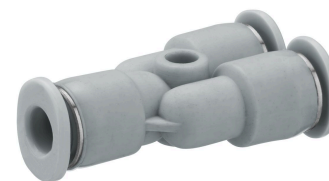

G	Ø D	Unité de livraison [Pcs.]	Référence
Ø 3	Ø 3	25	R412005429
Ø 4	Ø 4	25	R412005430
Ø 6	Ø 6	25	R412005431

## Dimensions

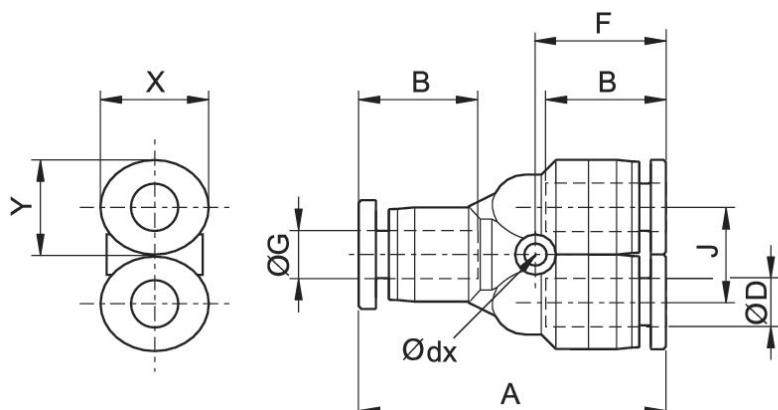

Référence	Orifice D	Orifice G	Ø dx	A	B	F	J	X	Y
R412005429	Ø 3	Ø 3	3.2	29.9	9.5	13.2	8	7	6
R412005430	Ø 4	Ø 4	3.2	30.1	11.5	13.3	8	10	8
R412005431	Ø 6	Ø 6	3.2	32.1	12.5	13.6	10.5	12	10



## Série QR1-S-MYR Mini

Raccord enfichable Y, réducteur  
Raccord instantané  
Raccord instantané

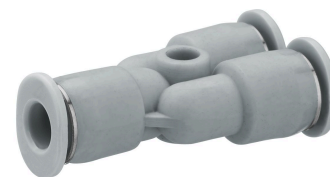

G	Ø D	Unité de livraison [Pcs.]	Référence
Ø 4	Ø 3	25	R412005432
Ø 6	Ø 4	25	R412005433

## Dimensions

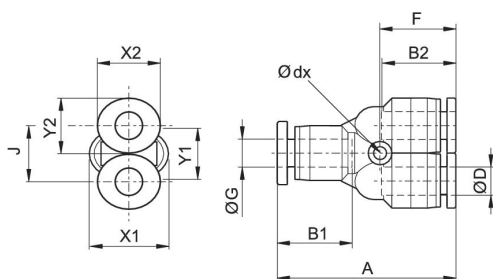

Référence	Orifice D	Orifice G	Ø dx	A	B1	B2	F	J	X1	X2
R412005432	Ø 3	Ø 4	3.2	30	11.5	9.5	13.4	8	10	7
R412005433	Ø 4	Ø 6	3.2	31.5	12.5	11.5	13.6	10.5	12	10

Référence	Y1	Y2
R412005432	8	6
R412005433	10	8

## Série QR1-S-MYZ Mini

Raccord instantané Y  
Prise femelle  
Raccord instantané



G	Ø D	Unité de livraison [Pcs.]	Référence
Ø 4	Ø 4	25	R412005443
Ø 6	Ø 6	25	R412005444

## Dimensions

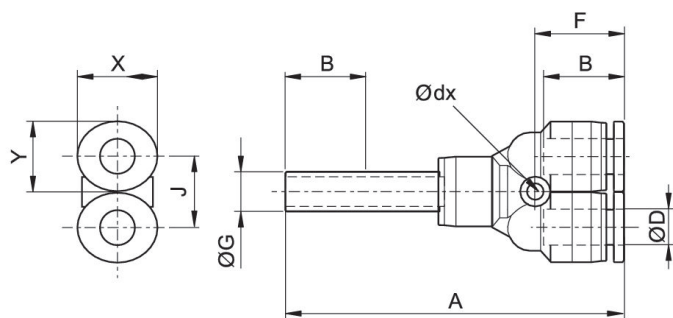

Référence	Orifice D	Orifice G	Ø dx	A	B	F	J	X	Y
R412005443	Ø 4	Ø 4	3.2	45	11.5	13.3	8	10	8
R412005444	Ø 6	Ø 6	3.2	50.5	12.5	13.6	10.4	12	10

# Efficient pneumatic solutions, our program: cylinders and drives, valves and valve systems, air supply management



Visit us: [Emerson.com/Aventics](https://www.emerson.com/Aventics)

Your local contact: [Emerson.com/contactus](https://www.emerson.com/contactus)



[Emerson.com](https://www.emerson.com)



[Facebook.com/EmersonAutomationSolutions](https://www.facebook.com/EmersonAutomationSolutions)



[LinkedIn.com/company/Emerson-Automation-Solutions](https://www.linkedin.com/company/Emerson-Automation-Solutions)



[Twitter.com/EMR\\_Automation](https://twitter.com/EMR_Automation)

An example configuration is depicted on the title page. The delivered product may thus vary from that in the illustration. Subject to change. This Document, as well as the data, specifications and other information set forth in it, are the exclusive property of AVENTICS GmbH. It may not be reproduced or given to third parties without its consent. Only use the AVENTICS products shown in industrial applications. Read the product documentation completely and carefully before using the product. Observe the applicable regulations and laws of the respective country. When integrating the product into applications, note the system manufacturer's specifications for safe use of the product. The data specified only serve to describe the product. No statements concerning a certain condition or suitability for a certain application can be derived from our information. The information given does not release the user from the obligation of own judgment and verification. It must be remembered that the products are subject to a natural process of wear and aging.

The Emerson logo is a trademark and service mark of Emerson Electric Co. Brand logotype are registered trademarks of one of the Emerson family of companies. All other marks are the property of their respective owners. © 2019 Emerson Electric Co. All rights reserved.



**CONSIDER IT SOLVED™**