

Silenziatori serie S11 AVENTICS



Serie SI1

I silenziatori serie SI1 AVENTICS offrono una vasta gamma di silenziatori anche in metallo o plastica, per ridurre il rumore quando i prodotti pneumatici effettuano lo scarico.



Silenziatori, serie SI1

filettatura esterna
bronzo sinterizzato



Raccordo aria compressa	Livello di pressione acustica [dB]	Portata nominale [l/min]	Unità di fornitura [Pezzo]	Peso [kg]	Codice
M5	72	398	10	0.004	1827000006
M7			10	0.005	8140000700
M10x1	75	1747	1	0.011	5324001110
M12x1,5	80	3049	1	0.019	5324001170
M14x1,5	80	3390	1	0.018	5324001120
M22x1,5	85	7223	1	0.071	5324001140
G 1/8	75	1623	10	0.01	1827000000
G 1/4		5950	10	0.013	R412004817
G 1/4	79	3390	10	0.02	1827000001
G 3/8	84	6554	5	0.05	1827000002
G 1/2	90	7223	2	0.08	1827000003
G 3/4	92	8394	1	0.13	1827000004
G 1	102	12848	1	0.18	1827000005

1827000006

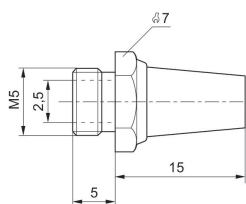

8140000700

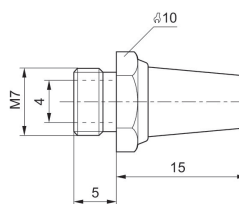

5324001110

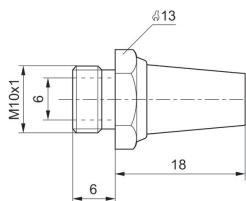

5324001170

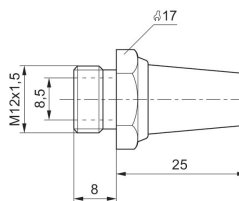

5324001120

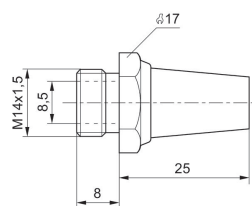

5324001140

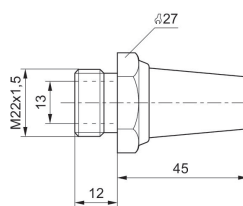

R412004817

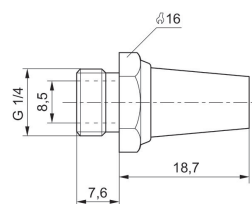

1827000001

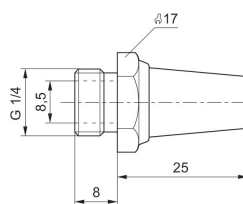

1827000002

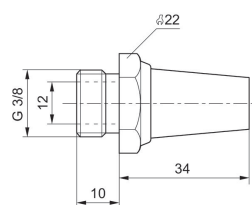

1827000003

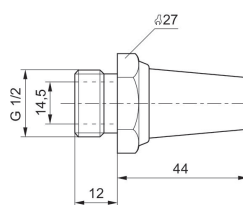

1827000004

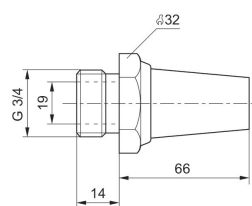

1827000005

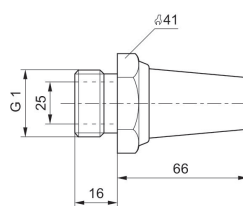

Silenziatori, serie SI1

filettatura esterna
bronzo sinterizzato

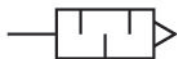

Raccordo aria compressa	Livello di pressione acustica [dB]	Portata nominale [l/min]	Unità di fornitura [Pezzo]	Peso [kg]	Codice
M5	79	252	10	0.005	1827000032
G 1/8	85	700	10	0.001	1827000031
G 1/4	88	1116	10	0.01	1827000033
G 3/8	90	1706	5	0.016	1827000034
G 1/2	85	2568	2	0.035	1827000035
G 3/4	82	3260	1	0.095	8145003400
G 1	82	9485	1	0.057	8145001000

Dimensioni

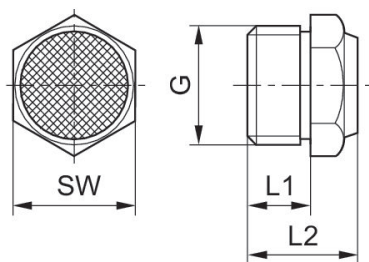

Codice	Raccordo G	L1	L2	SW
1827000032	M5	5	10.3	7
1827000031	G 1/8	6	11.5	13
1827000033	G 1/4	8	13.5	17
1827000034	G 3/8	10	17.5	22
1827000035	G 1/2	12	19.5	27
8145003400	G 3/4	14	22.5	32
8145001000	G 1	16	22.5	41

Livello di pressione acustica misurata a 6 bar alla distanza di 1 m

Silenziatori, serie SI1

filettatura esterna
bronzo sinterizzato

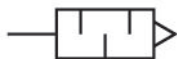

Raccordo aria compressa	Portata nominale [l/min]	Unità di fornitura [Pezzo]	Codice
G 1/8	311	10	1827430004
G 1/4	553	10	R414000155
G 3/8	743	5	R412007875
G 1/2	1343	2	R412007876
G 3/4	3585	2	R412007877
G 1	5012	2	R412007878

Dimensioni

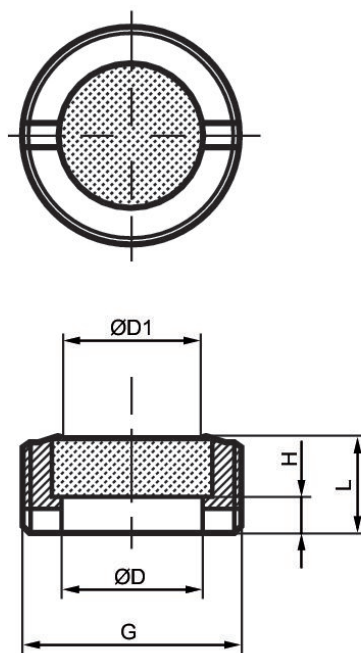

Codice	Raccordo G	Ø D	Ø D1	H	L
1827430004	G 1/8	6	5	2	4
R414000155	G 1/4	8	6	3	6
R412007875	G 3/8	10	8	3	7
R412007876	G 1/2	15	12	5	9

Codice	Raccordo G	Ø D	Ø D1	H	L
R412007877	G 3/4	20	17	3.4	8
R412007878	G 1	26	23	5.5	9.5

Silenziatori, serie SI1

bussola ad innesto
bronzo sinterizzato

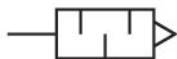

Raccordo aria compressa	Livello di pressione acustica [dB]	Portata nominale [l/min]	Unità di fornitura [Pezzo]	Peso [kg]	Codice
Ø 4	72	366	5	0.004	8240040000
Ø 6		1011	5	0.01	8240060000
Ø 8	75	2200	5	0.019	8240080000

Dimensioni

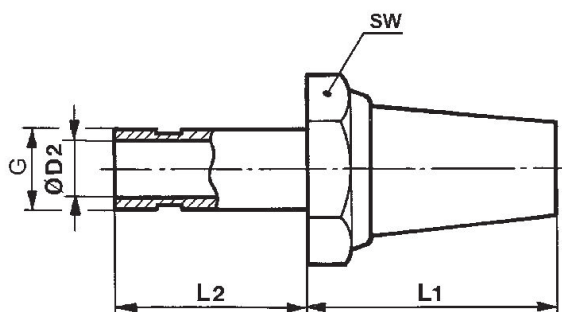

Codice	Raccordo G	Ø D2	L1	L2	SW
8240040000	Ø 4	2.5	16	17	10
8240060000	Ø 6	4	18	19	13
8240080000	Ø 8	6	25	19	17

Livello di pressione acustica misurata a 6 bar alla distanza di 1 m

Silenziatori, serie SI1

bussola ad innesto
bronzo sinterizzato



Raccordo aria compressa	Unità di fornitura [Pezzo]	Peso [kg]	Codice
Ø 4	2	0.002	1827000039
Ø 6	2	0.003	1827000041
Ø 8	2	0.004	1827000042
Ø 10	2	0.009	1827000043
Ø 12	2	0.011	1827000044
Ø 14	2	0.021	1827000045

Dimensioni

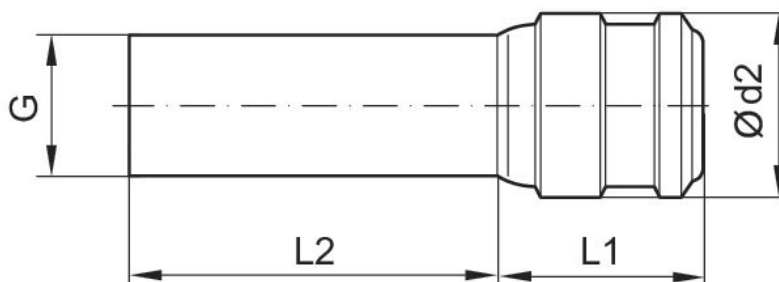
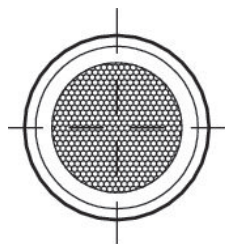

Codice	Raccordo G	Ø d2	L1	L2
1827000039	Ø 4	7	10	26
1827000041	Ø 6	8	10	33
1827000042	Ø8	10	13	31
1827000043	Ø10	12	14	36
1827000044	Ø12	14	16	40
1827000045	Ø14	17	18	40

Silenziatori, serie SI1

bronzo sinterizzato

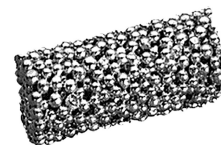

Peso [kg]	Codice
0.008	8993800114

Dimensioni

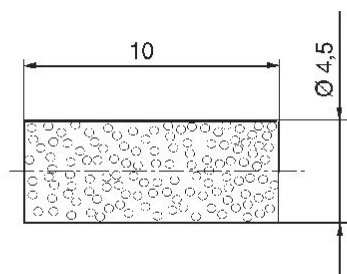

Silenziatori, serie SI1

filettatura esterna
Acciaio inox

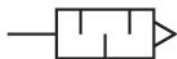

Raccordo aria compressa	Livello di pressione acustica [dB]	Portata nominale [l/min]	Unità di fornitura [Pezzo]	Peso [kg]	Codice
M5	68		10	0.006	R412010686
G 1/8	73	1218	10	0.01	R412010687
G 1/4	93	1937	10	0.002	R412007817

Dimensioni

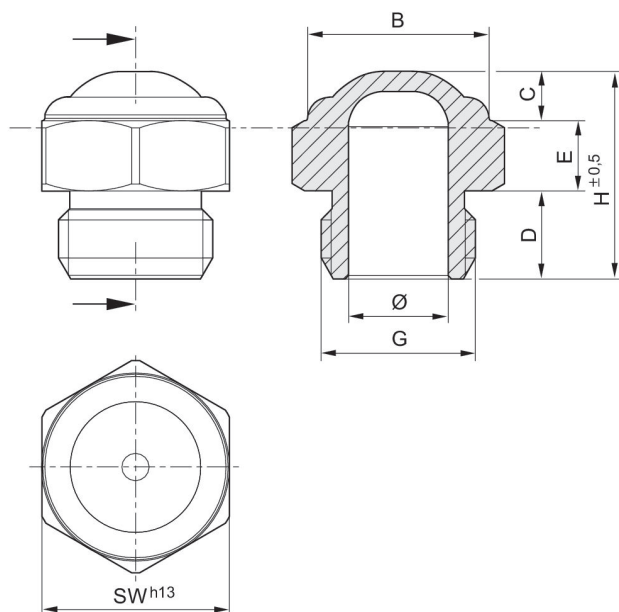

Codice	Raccordo G	Ø	B	D	E	H	SW
R412010686	M5	2.5	6.5	4	3	8	8
R412010687	G 1/8	6	11	6	4	15	13
R412007817	G 1/4	8.5	12	8	5	18	16

Silenziatori, serie SI1

filettatura esterna
Acciaio inox



Raccordo aria compressa	Livello di pressione acustica [dB]	Portata nominale [l/min]	Unità di fornitura [Pezzo]	Peso [kg]	Codice
M5	85	73	1	0.003	R412010090
G 1/8	90	1312	1	0.011	R412010081
G 1/4	93	1852	1	0.021	R412010082
G 3/8	101	2678	1	0.028	R412010083
G 1/2	95	5649	1	0.048	R412010084
G 3/4	110	5945	1	0.076	R412010085
G 1	100	7206	1	0.099	R412010086

Dimensioni

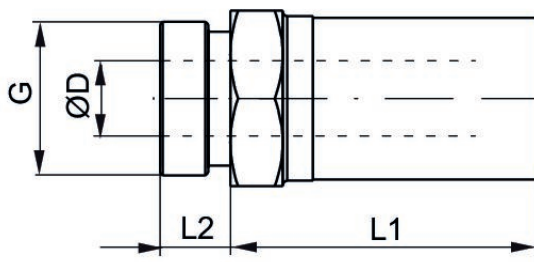

Codice	Raccordo G	SW	Ø D	L1	L2
R412010090	M5	8	3.1	10.5	3.5
R412010081	G 1/8	13	6.6	20	6
R412010082	G 1/4	16	8.6	29.5	7.5
R412010083	G 3/8	19	12.1	33.5	7.5
R412010084	G 1/2	24	15.3	39.5	9.5
R412010085	G 3/4	30	19.3	45	10
R412010086	G 1	36	25.5	49.5	11.5

Silenziatori, serie SI1

1300 l/min
Poliammide

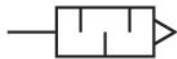

Livello di pressione acustica [dB]	Portata nominale [l/min]	Unità di fornitura [Pezzo]	Peso [kg]	Codice
78	1300	1	0.008	5790005312
78	1300	10	0.08	5790005332
78	1300	100	0.8	5790005352

Dimensioni

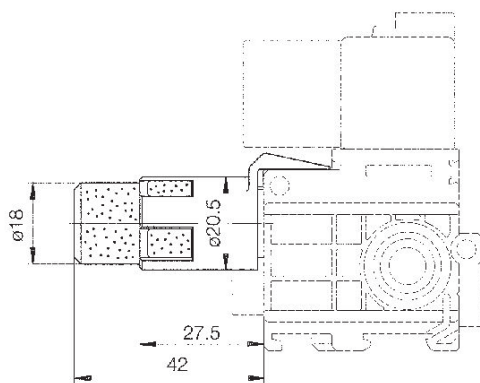

Silenziatori, serie SI1

filettatura esterna
Treccia metallica



Raccordo aria compressa	Livello di pressione acustica [dB]	Portata nominale [l/min]	Unità di fornitura [Pezzo]	Codice
G 1/8	94	1664	10	R412010283
G 1/4	96	2687	10	R412010245
G 3/8	98	4709	5	R412010246
G 1/2	100	6285	5	R412010247
G 3/4	102	6455	2	R412010248
G 1	104	10642	2	R412010249

Dimensioni

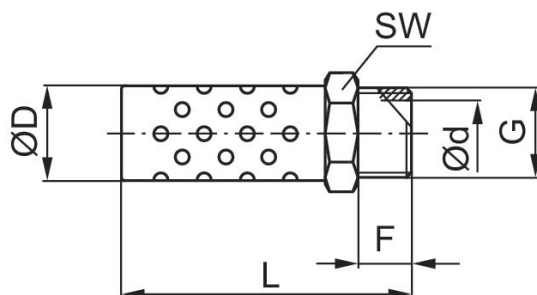

Codice	Raccordo G	L	F	D	d	SW
R412010283	G 1/8	33.5	6	10.4	6	11
R412010245	G 1/4	42.5	8.5	13.4	8.5	14
R412010246	G 3/8	49.2	9	16.5	12	17
R412010247	G 1/2	65.2	11	21.5	15	22
R412010248	G 3/4	74.5	12	26.5	20	27
R412010249	G 1	91	15.5	32.3	26	34

Livello di pressione acustica misurata a 6 bar alla distanza di 1 m

Silenziatori, serie SI1

filettatura esterna
polietilene



Raccordo aria compressa	Unità di fornitura [Pezzo]	Peso [kg]	Codice
G 3/4	1	0.383	1827010513

Dimensioni

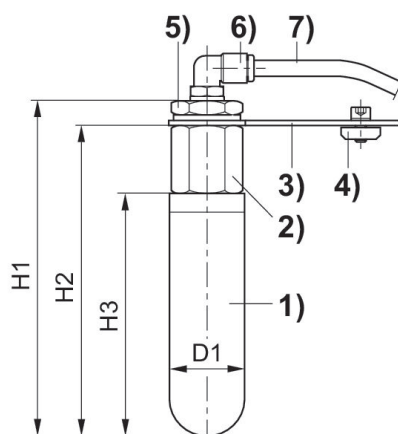

1) silenziatore (polietilene poroso sinterizzato) 2) manicotto di attacco G 3/4 3) piano di supporto (120x40x2,5) 4) 2 x M6x12 incluse piastrine per scanalatura 5) inserti di riduzione G 3/4 - G 1/4 6) raccordo avvitabile a gomito orientabile Ø 8 mm 7) tubo flessibile PU Ø 8 mm, lunghezza 250 mm

Codice	Raccordo	H1	H2	H3	D1
1827010513	G 3/4	174	161	126	38.5

Silenziatori, Serie EBS

filettatura esterna
polietilene

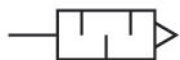
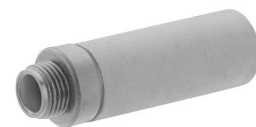

Raccordo aria compressa	Unità di fornitura [Pezzo]	Peso [kg]	Codice
M5	5	0.001	R412007592
G 1/8	5	0.005	R412007593
G 3/8	5	0.014	R412007594

Dimensioni

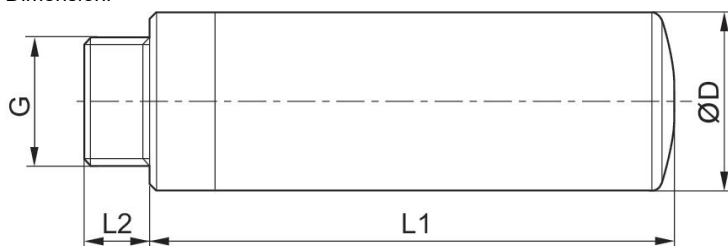

Codice	Raccordo G	L1	L2	Ø D
R412007592	M5	24	4	9
R412007593	G 1/8	40	5	13,6
R412007594	G 3/8	76	9	20

Silenziatori, Serie ECV

filettatura esterna
polietilene

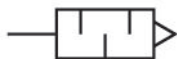
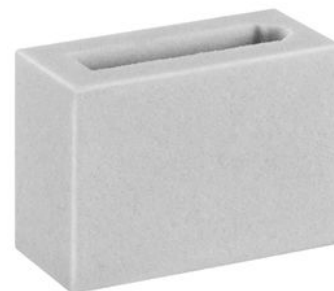

Unità di fornitura [Pezzo]	Peso [kg]	Codice
2	0.005	R412010100

Dimensioni

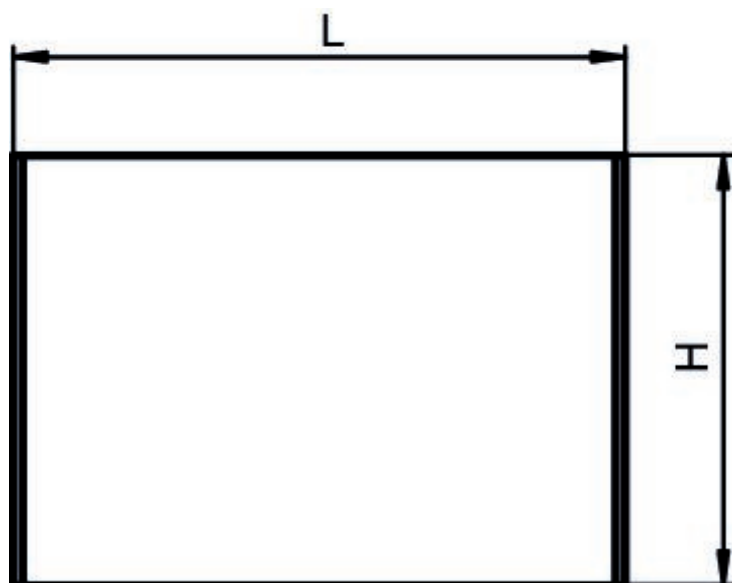

Codice	B	H	L
R412010100	15	22,5	32

Silenziatori, serie SI1

bussola ad innesto
polietilene

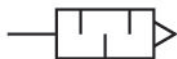
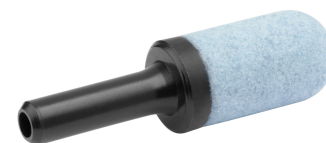

Raccordo aria compressa	Livello di pressione acustica [dB]	Portata nominale [l/min]	Unità di fornitura [Pezzo]	Peso [kg]	Codice
Ø 4		321	5	0.002	R412007519
Ø 6	82	680	5	0.002	R412007899
Ø 6	80	622	5	0.002	R412000591
Ø 8	90	1366	5	0.002	R412007520
Ø 10	95	2854	5	0.004	R412000593
Ø 12	97	3870	5	0.007	R412007715

Dimensioni

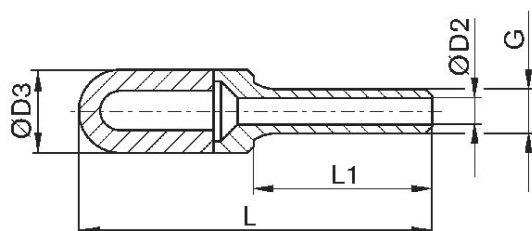

Codice	Raccordo G	Ø D2	Ø D3	L1	L
R412007519	Ø 4	2.5	7	16	32
R412007899	Ø 6	3.5	10	20.5	45
R412000591	Ø 6	3.5	12.5	20.5	45
R412007520	Ø 8	4.8	13.5	21.5	43.5
R412000593	Ø 10	6.9	15.5	26.5	57.5
R412007715	Ø 12	8.4	18.5	29	82

Silenziatori, Serie SI1 - inch

bussola ad innesto
polietilene

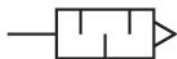
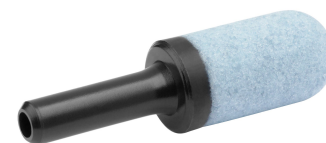

Raccordo aria compressa	Portata nominale [l/min]	Unità di fornitura [Pezzo]	Peso [kg]	Codice
Ø 1/4"	60	5	0.002	R412005727
3/8"	30	5	0.007	R412005728
Ø 1/2"	30	5	0.007	R412007714

Dimensioni in pollici

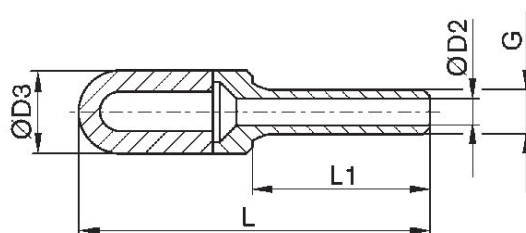

Codice	Raccordo G	Ø D2	Ø D3	L1	L
R412005727	Ø 1/4"	0.14	0.49	0.81	1.77
R412005728	3/8"	0.26	0.61	1.04	2.26
R412007714	Ø 1/2"	0.36	0.73	1.14	3.23

Silenziatori, serie SI1

filettatura esterna
polietilene

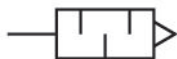

Raccordo aria compressa	Livello di pressione acustica [dB]	Portata nominale [l/min]	Unità di fornitura [Pezzo]	Peso [kg]	Codice
M5		381	5	0.001	1827000018
G 1/8	78	1560	5	0.002	1827000019
G 1/4	80	3447	5	0.003	1827000020
G 3/8	85	5682	2	0.008	1827000021
G 1/2	88	7142	1	0.013	1827000022
G 3/4		8356	1	0.04	1827000023
G 1		13329	1	0.055	1827000024

Dimensioni

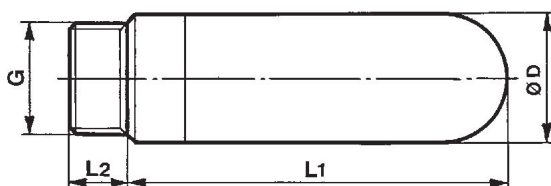

Codice	Raccordo G	Ø D	L1	L2
1827000018	M5	6.5	17.5	4
1827000019	G 1/8	12.5	28.5	5.5
1827000020	G 1/4	15.5	34.5	8
1827000021	G 3/8	18.5	56	11.5
1827000022	G 1/2	23.3	66.5	11
1827000023	G 3/4	38.5	115.5	16
1827000024	G 1	49	140	21

Tappo scarico, Serie SI1

filettatura esterna



Raccordo aria compressa	Unità di fornitura [Pezzo]	Peso [kg]	Codice
R 1/8	10	0.004	8994701700
R 1/4	10	0.007	8994701900

Dimensioni

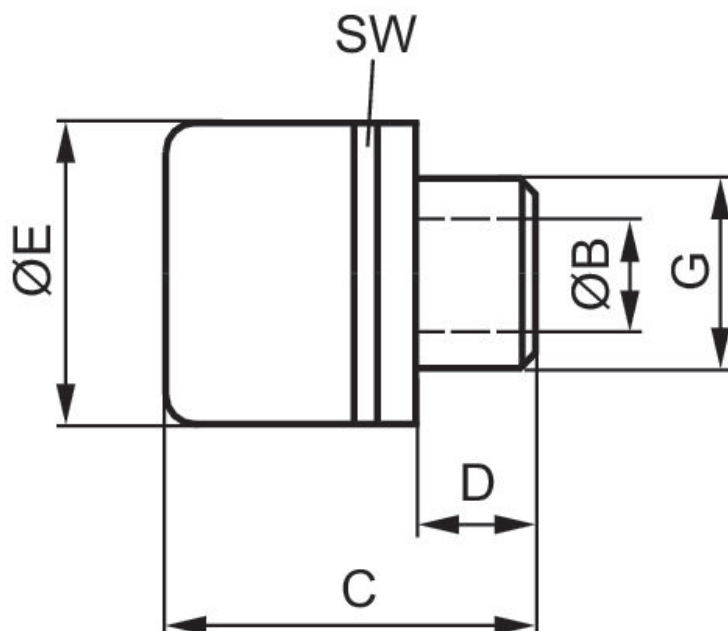

Codice	Raccordo G	B	C	D	E	SW
8994701700	R 1/8	5	19	6.5	15	14
8994701900	R 1/4	8	20.5	8	20	19

Tappo scarico, Serie SI1

filettatura esterna



Raccordo aria compressa	Unità di fornitura [Pezzo]	Peso [kg]	Codice
R 3/8	5	0.067	8994701200

Dimensioni

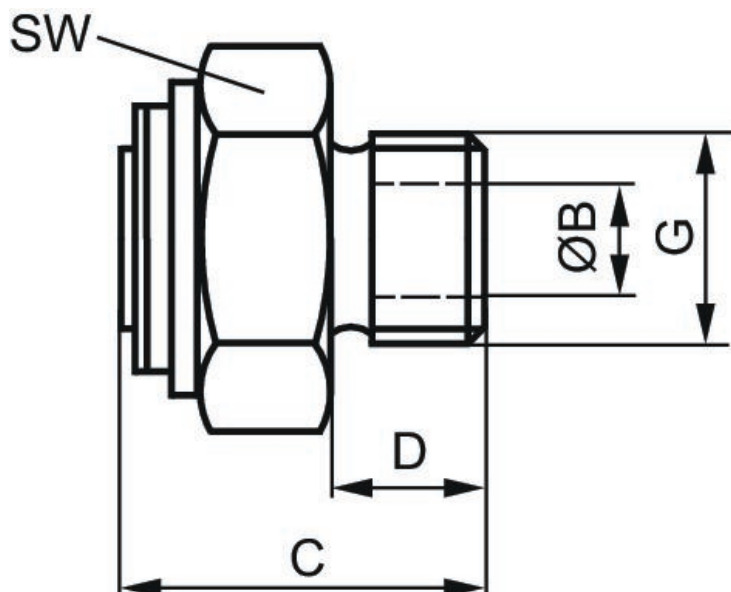

Codice	Raccordo G	B	C	D	E	SW	Fig.
8994701200	R 3/8	9	30	12	-	27	2

Efficient pneumatic solutions, our program: cylinders and drives, valves and valve systems, air supply management



Visit us: [Emerson.com/Aventics](https://www.emerson.com/aventics)

Your local contact: [Emerson.com/contactus](https://www.emerson.com/contactus)



[Emerson.com](https://www.emerson.com)



[Facebook.com/EmersonAutomationSolutions](https://www.facebook.com/EmersonAutomationSolutions)



[LinkedIn.com/company/Emerson-Automation-Solutions](https://www.linkedin.com/company/Emerson-Automation-Solutions)



[Twitter.com/EMR_Automation](https://twitter.com/EMR_Automation)

An example configuration is depicted on the title page. The delivered product may thus vary from that in the illustration. Subject to change. This Document, as well as the data, specifications and other information set forth in it, are the exclusive property of AVENTICS GmbH. It may not be reproduced or given to third parties without its consent. Only use the AVENTICS products shown in industrial applications. Read the product documentation completely and carefully before using the product. Observe the applicable regulations and laws of the respective country. When integrating the product into applications, note the system manufacturer's specifications for safe use of the product. The data specified only serve to describe the product. No statements concerning a certain condition or suitability for a certain application can be derived from our information. The information given does not release the user from the obligation of own judgment and verification. It must be remembered that the products are subject to a natural process of wear and aging.

The Emerson logo is a trademark and service mark of Emerson Electric Co. Brand logotype are registered trademarks of one of the Emerson family of companies. All other marks are the property of their respective owners. © 2019 Emerson Electric Co. All rights reserved.



CONSIDER IT SOLVED™