

Escuadras bajas AVENTICS



Datos técnicos

Sector
Versión

Industria
RAK - 1S, RAK - 2S, RAK - 3S, RAK - 4S, RAK -
5S, RAK - 5D

Material

Material carcasa
Superficie Carcasa
N° de material

Acero, cromado
galvanizado
2706152000

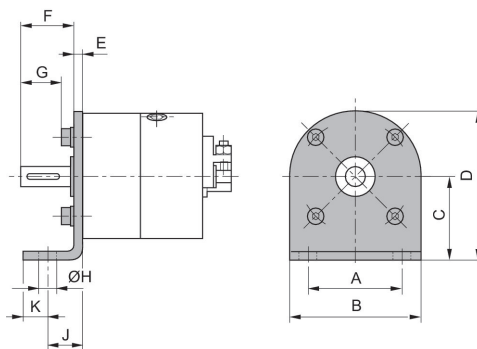

Fijación por pie

2706152000

Fijaciones
por pie

2023-11-06

Para serie	N° de material	A	B	C	D	E	F	G	H
RAK - 1S	2706112000	20	30	22	37	2	14	10.3	4.8
RAK - 2S	2706122000	26	36	25	43	2.6	16.4	12.7	4.8
RAK - 3S	2706132000	30	42	30	51	3.2	19.8	16.1	5.8
RAK - 4S	2706142000	36	49	34	58	3.6	25	18.7	6.5
RAK - 5S, RAK - 5D	2706152000	48	66	42	75	4.5	27	20.7	6.5

Para serie	J	K
RAK - 1S	10	5
RAK - 2S	11	7
RAK - 3S	12	8
RAK - 4S	15	10
RAK - 5S, RAK - 5D	18	12