

Rotary wing drives, Series RAK

2705070300

AVENTICS
Series RAK
Rotary wing
drives

2024-04-05

AVENTICS Series RAK Rotary wing drives

The AVENTICS Series RAK is an efficient and easy way to generate torque from compressed air, in a very compact size. They are ideal for the compact applications in a wide range of industries such as, packaging, process, electronics etc.



Technical data

Industry	Industrial
Compressed air connection	G 1/4
Rotary compact module version	Rotary wing drive, double-acting
axis geometry	single
Frame size	RAK - 7S
Type	Single vane
Axis diameter	17 mm 17 mm 25 mm
Theoretical torque at	6 bar
Min. swivel times	0.24 s
Maximum operating frequency	80
Interior volume	146 cm ³
Max. permissible axial bearing load	88.2 N
Radial shaft load	1176 N
Theoretical torque	18 Nm
Permissible kinetic energy	0.225 J
Repetitive precision	3 °
Max. angle of rotation	180 °
Min. working pressure	2 bar

Rotary wing drives, Series RAK

2705070300

AVENTICS
Series RAK
Rotary wing
drives

2024-04-05

Max. working pressure	10 bar
Min. ambient temperature	5 °C
Max. ambient temperature	60 °C
Min. medium temperature	5 °C
Max. medium temperature	60 °C
Medium	Compressed air
Min. oil content of compressed air	0 mg/m ³
Max. oil content of compressed air	1 mg/m ³
Max. particle size	5 µm
Weight	1.9 kg

Material

Housing material	Aluminum
Surface housing	painted/powder-coated
Seal material	Acrylonitrile butadiene rubber
Material axis	Stainless Steel
Part No.	2705070300

Technical information

The pressure dew point must be at least 15 °C less than ambient and medium temperature and may not exceed 3 °C.

The oil content of compressed air must remain constant during the life cycle.

Use only the approved oils from AVENTICS. Further information can be found in the “Technical information” document (available in <https://www.emerson.com/en-us/support>).

Rotary wing drives, Series RAK

2705070300

AVENTICS
Series RAK
Rotary wing
drives

2024-04-05

Dimensions

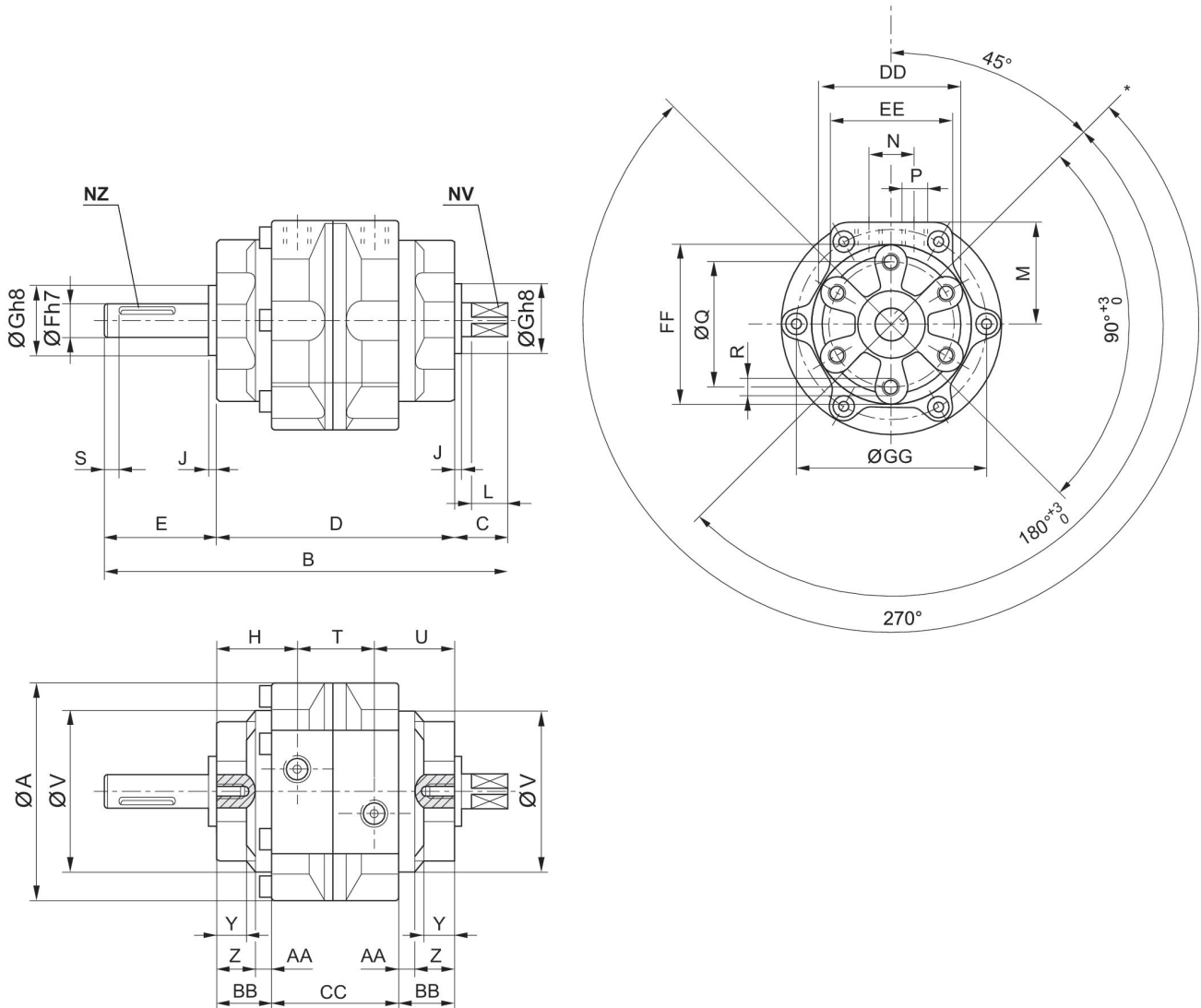

* Oscillating reference point

Frame size	Part No.	A	B	C	D	E	F	G	H
RAK-6S	2705060300	79	145	19.5	86	39.5	12	25	29
RAK-6S	2705062800	79	145	19.5	86	39.5	12	25	29
RAK-6D	2705061100	79	145	19.5	86	39.5	12	25	29
RAK-7S	2705070300	110	180	23.5	103	53.5	17	30	34.5
RAK-7S	2705072700	110	180	23.5	103	53.5	17	30	34.5
RAK-7D	2705071100	110	180	23.5	103	53.5	17	30	34.5
RAK-8S	2705080300	141.5	220	30	125	65	25	45	41.5
RAK-8D	2705081100	141.5	220	30	125	65	25	45	41.5

Frame size	J	L	M	N	P	Q	R	S	T
RAK-6S	2.5	13	36	16	G 1/8	45	M6x1	5	28

Rotary wing drives, Series RAK

2705070300

AVENTICS
Series RAK
Rotary wing
drives

Frame size	J	L	M	N	P	Q	R	S	T
RAK-6S	2.5	13	36	16	G 1/8	45	M6x1	5	28
RAK-6D	2.5	13	36	16	G 1/8	45	M6x1	5	28
RAK-7S	3	16	51	24	G 1/4	70	M8x1,25	5	34
RAK-7S	3	16	51	24	G 1/4	70	M8x1,25	5	34
RAK-7D	3	16	51	24	G 1/4	70	M8x1,25	5	34
RAK-8S	3.5	22	66	32	G 3/8	80	M10x1,5	5	-
RAK-8D	3.5	22	66	32	G 3/8	80	M10x1,5	5	-

Frame size	U	V	Y	Z	AA	BB	CC	DD	EE
RAK-6S	29	58	11	14	6	20	46	51	44
RAK-6S	29	58	11	14	6	20	46	51	44
RAK-6D	29	58	11	14	6	20	46	51	44
RAK-7S	34.5	85.2	10.5	15.5	8	23.5	56	75	61
RAK-7S	34.5	85.2	10.5	15.5	8	23.5	56	75	61
RAK-7D	34.5	85.2	10.5	15.5	8	23.5	56	75	61
RAK-8S	41.5	110	13	17.5	10	27.5	70	88.5	78
RAK-8D	41.5	110	13	17.5	10	27.5	70	88.5	78

Frame size	FF	GG	NV	NZ 1)
RAK-6S	57	68	10	4x2,5x20
RAK-6S	57	68	10	4x2,5x20
RAK-6D	57	68	10	4x2,5x20
RAK-7S	85	97	13	5x3x36
RAK-7S	85	97	13	5x3x36
RAK-7D	85	97	13	5x3x36
RAK-8S	98.5	125	19	7x4x40
RAK-8D	98.5	125	19	7x4x40

1) Groove: width x depth x length

Effective torque

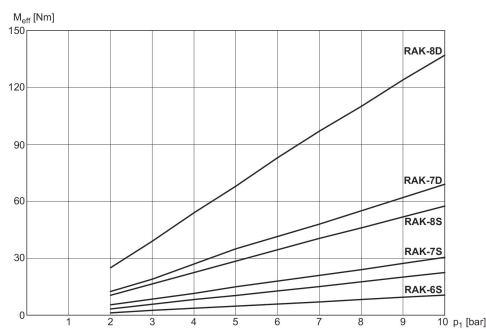

M_{eff} : effective torque

Rotary wing drives, Series RAK

2705070300

AVENTICS
Series RAK
Rotary wing
drives

2024-04-05

Overview drawing

RAK - 1S, RAK - 2S, RAK - 3S
RAK - 4S, RAK - 5S, RAK - 5D

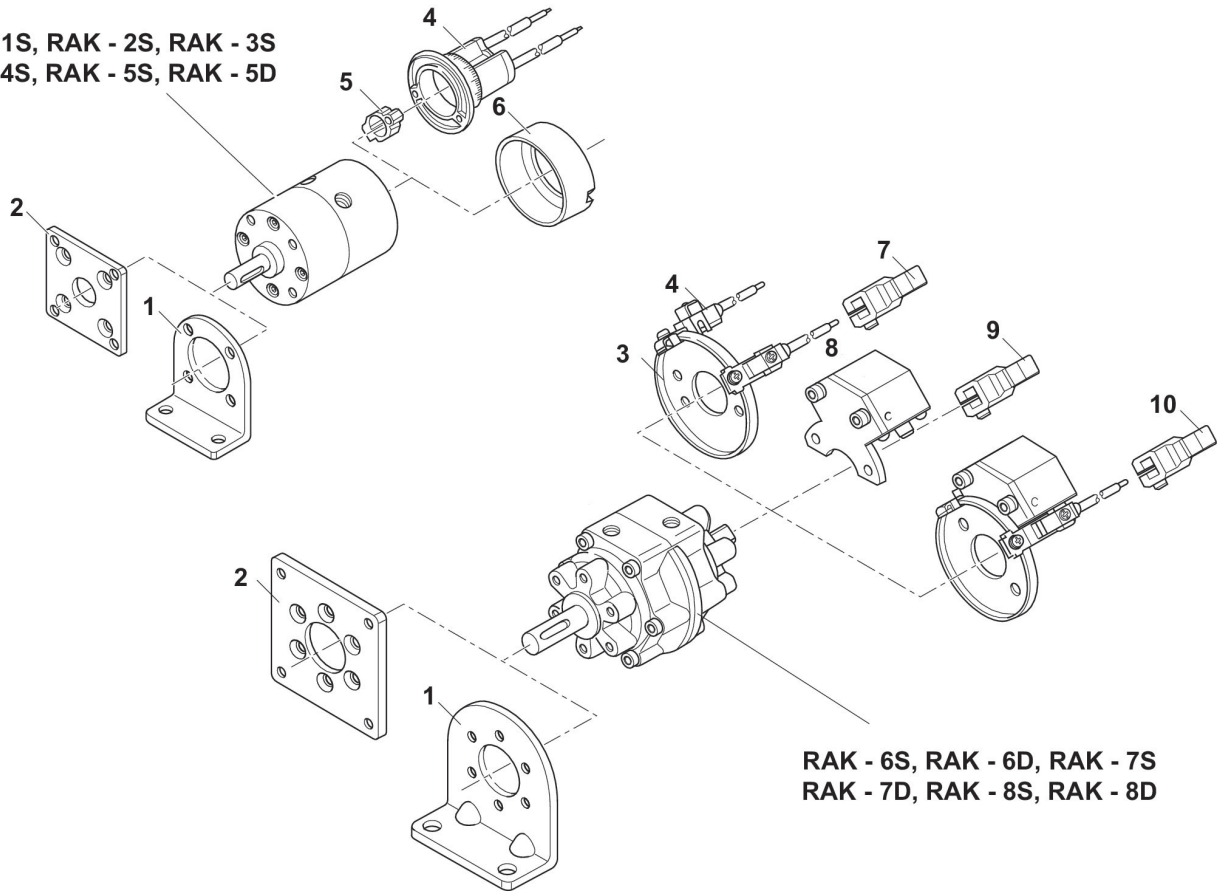

RAK - 6S, RAK - 6D, RAK - 7S
RAK - 7D, RAK - 8S, RAK - 8D

1) foot mounting 2) flange mounting 3) mounting plate for sensor 4) sensor unit 5) Magnet 6) Protective cover 7) swivel arm with magnet 8) hydraulic shock absorber 9) swivel arm without magnet 10) swivel arm with magnet
NOTE: This overview drawing is only for orientation to indicate where the various accessory parts can be fastened to the cylinder. The illustration has been simplified for this purpose. It is thus not possible to derive the dimensions from this overview.