

Valve plug connector, series CON-VP

1834484213

Valve plug connector with cable, series CON-VP

- Valve plug connector with connected cable
- Form A EN 175301-803
- Form B ISO 6952 and B industry
- Form C ISO 15217 and C industry
- With/without protective circuit/LED

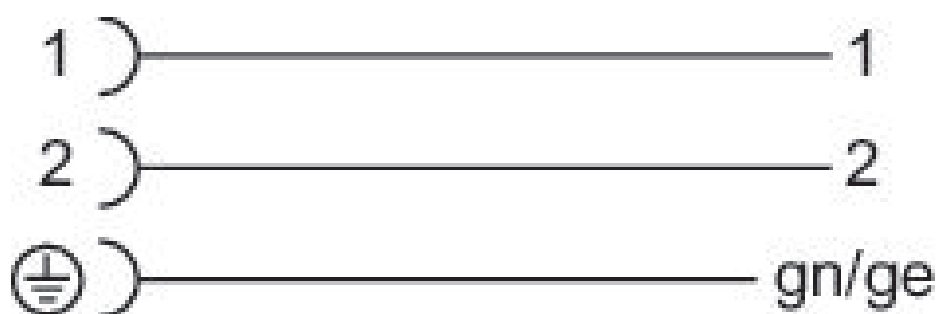
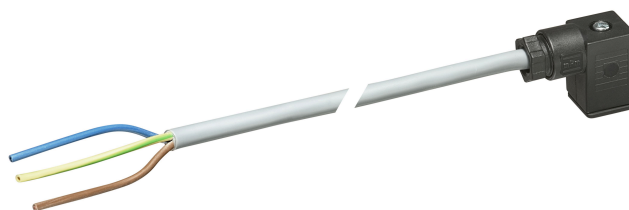

Technical data

Industry
Industrial

Type
Valve plugs

Cable
with cable

Operational voltage
230 V AC/DC

Operating voltage AC max.
230 V DC

Operating voltage DC, max.
230 V AC

Electrical connection 1, type
Socket

Electrical connection 1, thread size
form C

Electrical connection 1, number of poles
2+E

Cable exit
angled

Cable exit angle
90°

Electrical connection 2, type
open cable ends

Electrical connection 2, number of poles
3-pin

Contact assignment
2+E

Number of wires	Max. current
3	6 A
Shielding	Wire cross-section
unshielded	0.75 mm ²
Cable length	Cable-Ø
3 m	5.9 mm
Protection class	Mounting screw tightening torque
IP67	0.4 Nm
Min. ambient temperature	Weight
-20 °C	0.183 kg
Max. ambient temperature	
80 °C	

Material

Seal material	Part No.
caoutchouc/butadiene caoutchouc	1834484213
Material cable sheath	
Polyvinyl chloride	

Technical information

The specified protection class is only valid in assembled and tested state.

Fig. 2
Dimensions in mm

180° female insert

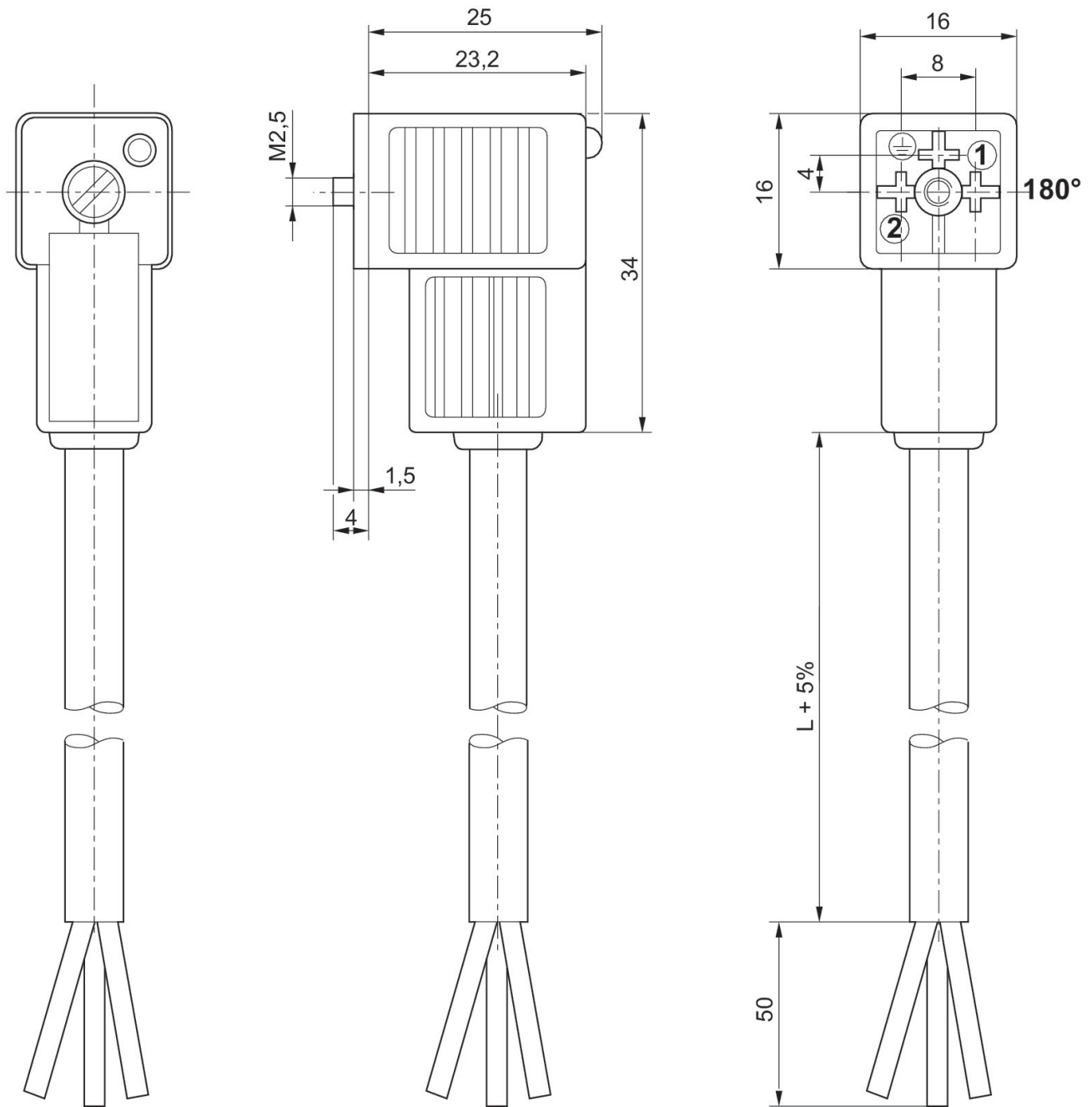

Fig. 1
Dimensions in mm

0° female insert

