

Valve plug connector, series CON-VP

1834484204

Valve plug connector with cable, series CON-VP

- Valve plug connector with connected cable
- Form A EN 175301-803
- Form B ISO 6952 and B industry
- Form C ISO 15217 and C industry
- With/without protective circuit/LED

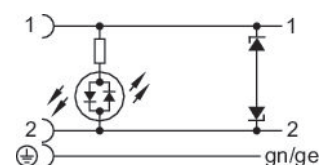
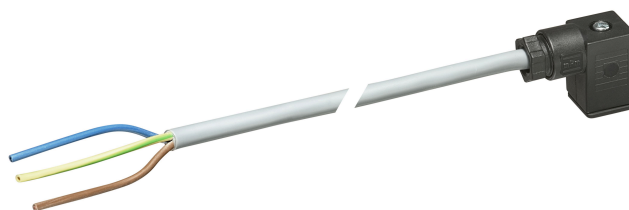

Technical data

Industry
Industrial

Type
Valve plugs

Cable
with cable

Operational voltage
24 V AC/DC

Operating voltage AC max.
24 V DC

Operating voltage DC, max.
24 V AC

Electrical connection 1, type
Socket

Electrical connection 1, thread size
form C

Electrical connection 1, number of poles
2+E

Cable exit
angled

Cable exit angle
90°

Electrical connection 2, type
open cable ends

Electrical connection 2, number of poles
3-pin

Contact assignment
2+E

Number of wires
3

Shielding
unshielded

Cable length
3 m

Protection class
IP67

Protective circuit

Z-diode

Min. ambient temperature

-20 °C

Max. ambient temperature

80 °C

Max. current

6 A

with LED

Yellow

Wire cross-section

0.75 mm²

Cable-Ø

5.9 mm

Mounting screw tightening torque

0.4 Nm

Weight

0.185 kg

Material

Seal material

caoutchouc/butadiene caoutchouc

Material cable sheath

Polyvinyl chloride

Part No.

1834484204

Technical information

The specified protection class is only valid in assembled and tested state.

Fig. 2

Dimensions in mm

180° female insert

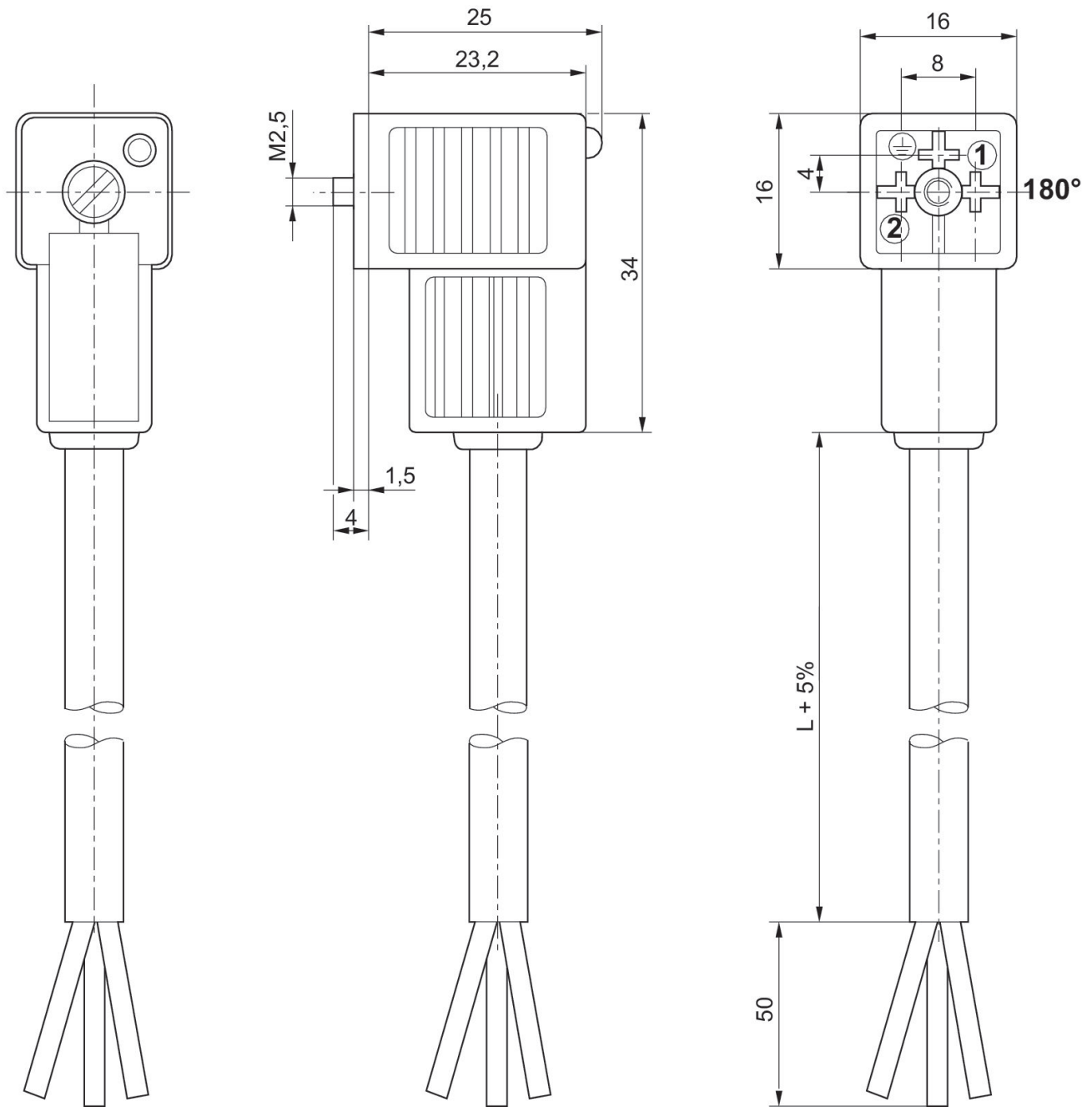

Fig. 1
Dimensions in mm

0° female insert

