

Mounting flange, Series LU1

1827001505

Locking units, LU1/LU2

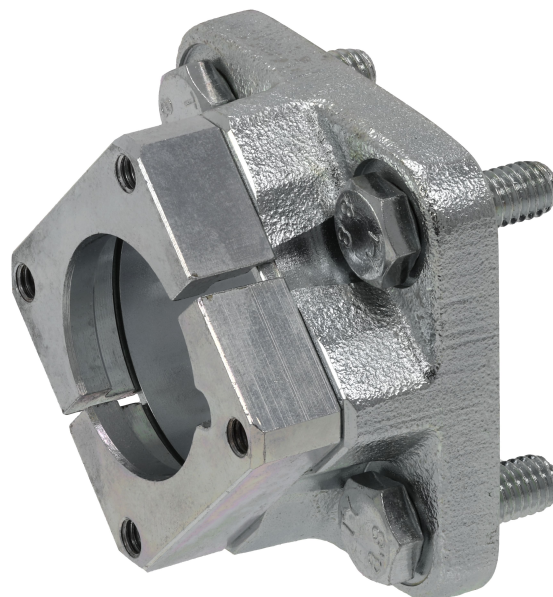

Technical data

Industry	Industrial
Type	for cylinders with locking units
Piston Ø	40 mm
Piston diameter	40 mm
Min. medium temperature	-20 °C
Max. medium temperature	80 °C
Min. ambient temperature	-20 °C
Max. ambient temperature	80 °C
Weight	0.36 kg

Material

Housing	Nodular graphite iron
Surface housing	galvanized
Part No.	1827001505

Dimensions

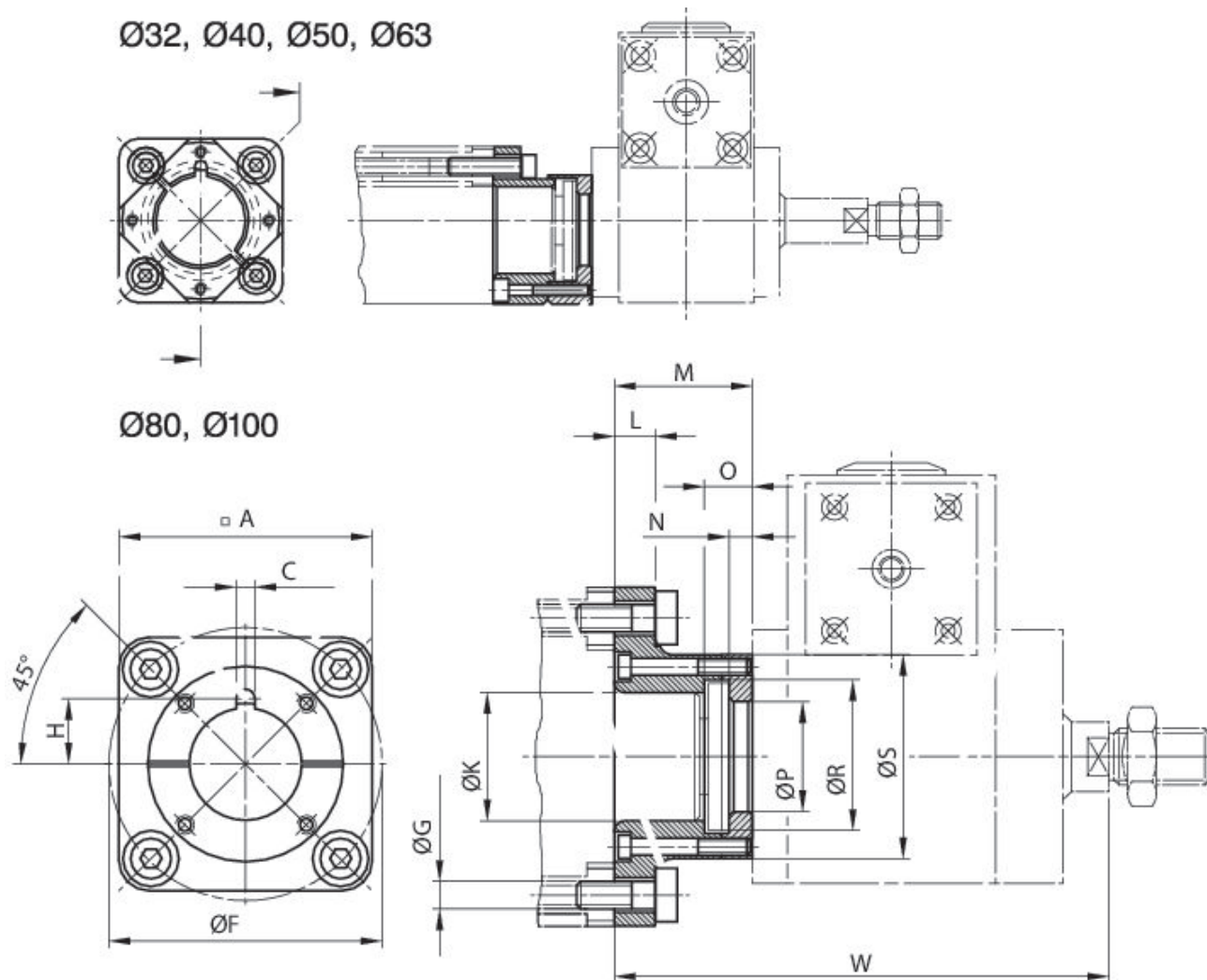

Screws included in scope of delivery
The locking unit can be rotated by 4x90°.

Piston Ø	Part No.	A	C +0,1	Ø F ±0,2	G H13	H	Ø K H10	L	M
32	1827001504	50	3.6	46	6.6	13.2	30	7	27.2
40	1827001505	57	3.6	54	6.6	18.2	35	9.5	33.3
50	1827001506	68	3.6	66	8.4	18.2	40	11	38.3
63	1827001508	75	3.6	80	8.4	18.2	45	11	38.3
80	1827001433	95	6	102	10.5	24.5	45	15	52
100	1827001434	115	6	126	10.5	24.6	55	15	57

Piston Ø	N -0,1	O	Ø P +0,2	Ø R +0,5	Ø S	W
32	3.9	8	24.2	33	46.5	105
40	4.9	10	30.2	40	55.5	111
50	4.9	10	30.2	40	66	137
63	4.9	10	30.2	40	71	137

Piston Ø	N -0,1	O	Ø P +0,2	Ø R +0,5	Ø S	W
80	7.9	16	40.2	55	75	186
100	7.9	16	40.2	55	80	191