

Montajes de brida AVENTICS

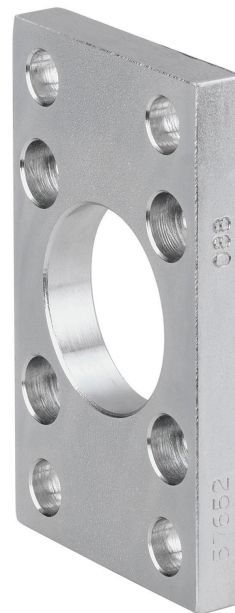

Datos técnicos

Sector

Industria

Normalización

ISO 15552

Diámetro de émbolo

50 mm

Material

Material carcasa

Acero, cromado

Superficie Carcasa

galvanizado

Material de los tornillos

Acero, cromado

Superficie tornillos

galvanizado

N° de material

1827001279

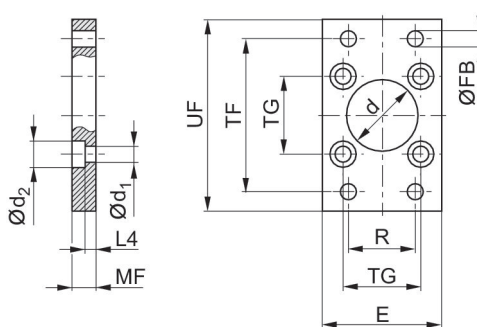

Fijación por brida MF1, MF2, Serie CM1

1827001279

Fijaciones
por brida

2023-11-14

Ø del émbolo	N° de material	Ød H11	Ød1	Ød2	E máx.	ØFB	L4	MF	R
32	1827001277	30	6.6	11	50	7	4.5	10	32
40	1827001278	35	6.6	11	55	9	4.5	10	36
50	1827001279	40	9	15	65	9	6	12	45
63	1827001499	45	9	15	75	9	6	12	50
80	1827001281	45	11	18	100	12	9	16	63
100	1827001282	55	11	18	120	14	9	16	75
125	1827004861	60	14	20	140	16	10.5	20	90
160	1827001460	65	18	26	180	18	9.5	20	115
200	1827001461	75	18	26	220	22	12.5	25	135
250	1827001462	90	22	33	280	26	10.5	25	165
320	5239016012	110	26	40	350	33	15	30	200

Ø del émbolo	TF	TG	UF
32	64	32,5 ±0,2	80
40	72	38 ±0,2	90
50	90	46,5 ±0,2	110
63	100	56,5 ±0,2	125
80	126	72 ±0,2	154
100	150	89 ±0,2	186
125	180	110 ±0,3	220
160	230	140 ±0,3	275
200	270	175 ±0,3	312
250	330	220 ±0,3	380
320	270	270 ±0,3	400