

# Bearing block AB7-HD, Series CM1

1825805276

Bearing  
block

2023-11-14

## AVENTICS Bearing blocks



### Technical data

Industry

Industrial

Version

Suitable for robust mechanical engineering applications with fixed bearing

Standardization

ISO 15552

Piston diameter

40 mm

Swivel bearing Ø

12 mm

### Material

Housing material

Nodular graphite iron

Surface housing

galvanized

Screws material

Galvanized Steel

Part No.

1825805276

Dimensions

# Bearing block AB7-HD, Series CM1

1825805276

Bearing  
block

2023-11-14

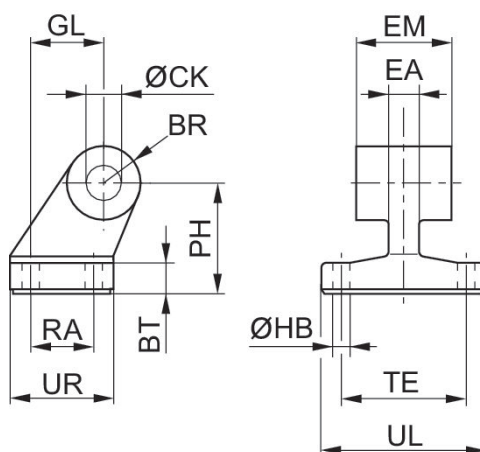

Part No.	Piston Ø	BR	BT	Ø CK H9	Ø HB H13	EM	GL JS14	EA max.	PH JS15
1825805275	32	10	8	10	6.6	26 -0,2/-0,6	21	10	32
1825805276	40	11	10	12	6.6	28 -0,2/-0,6	24	12	36
1825805277	50	13	12	12	9	32 -0,2/-0,6	33	16	45
1825805278	63	15	12	16	9	40 -0,2/-0,6	37	16	50
1825805279	80	15	14	16	11	50 -0,2/-0,6	47	20	63
1825805280	100	19	15	20	11	60 -0,2/-0,6	55	20	71
1825805281	125	22,5	20	25	14	70 -0,5/-1,5	70	30	90
1825805282	160	31.5	25	30	14	90 -0,5/-1,5	97	36	115
1825805283	200	31.5	30	30	18	90 -0,5/-1,5	105	40	135
1825805284	250	40	35	40	22	110 -0,5/-1,5	128	45	165
5239013422	320	45	40	45	26	120 -0,5/-1,5	150	55	200

Part No.	RA JS14	TE JS14	UL max.	UR max.
1825805275	18	38	51	31
1825805276	22	41	54	35
1825805277	30	50	65	45
1825805278	35	52	67	50
1825805279	40	66	86	60
1825805280	50	76	96	70
1825805281	60	94	124	90
1825805282	88	118	156	126
1825805283	90	122	162	130
1825805284	110	150	200	160
5239013422	122	170	234	186