

Vis d'obturation et connecteurs AVENTICS

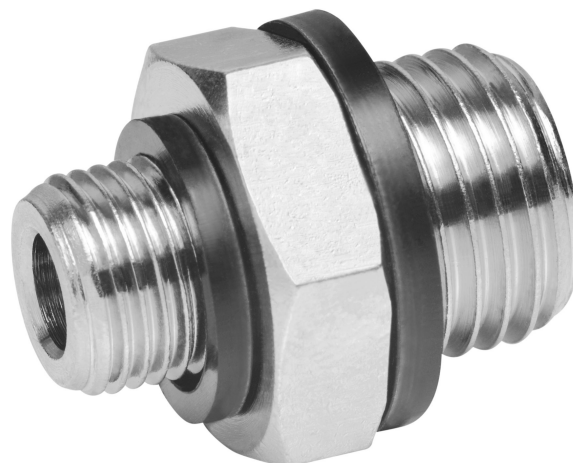

Données techniques

Secteur	Industrie
Type de raccordement d'air comprimé	Filetage
Orifice G	G 3/4
Type de raccordement d'air comprimé 2	Filetage
Orifice D	G 1/2
Type	FPT-S-RDO
Pression de service min.	0 bar
Pression de service maxi	16 bar
Température ambiante min.	-20 °C
Température ambiante max.	80 °C
Unité de livraison	2 Pcs.

Matériau

Matériau	Laiton
Surface	nickelé
Matériau joints	Chlorure de polyvinyle (PVC)
Surface Joint	dur
Référence	1823391286

Dimensions

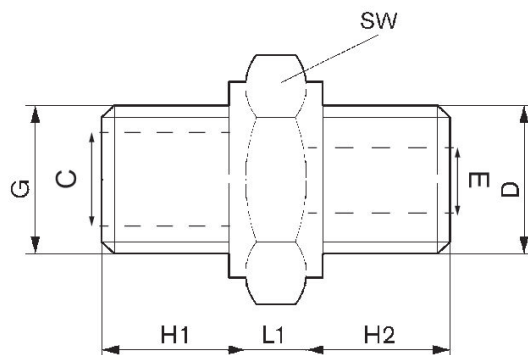

Référence	Orifice D	Orifice G	ØC	ØE	H1	H2	L1	SW
1823391081	M5	M5	-	2	4.5	4.5	4	8
1823391100	M5	G 1/8	-	-	7	5	5	13
1823391015	G 1/8	G 1/8	8	5	7.5	7.5	4	14
1823391016	G 1/8	G 1/4	8	5	10	7	5	17
1823391017	G 1/4	G 1/4	8	7.5	10	10	5	17
1823391018	G 1/4	G 3/8	12	7.5	10	10	5	22
1823391019	G 3/8	G 3/8	12	10	10	10	5	22
1823391020	G 3/8	G 1/2	15	10	12	10	6	27
1823391029	G 1/2	G 1/2	15	13	12	12	6	27
1823391286	G 1/2	G 3/4	20	13	12	12	7	32
1823391287	G 3/4	G 3/4	20	18	12	12	7	32
1823391288	G 3/4	G 1	25	18	15	12	8	41
1823391289	G 1	G 1	25	22	15	15	8	41