

## AVENTICS Blanking screws and connectors

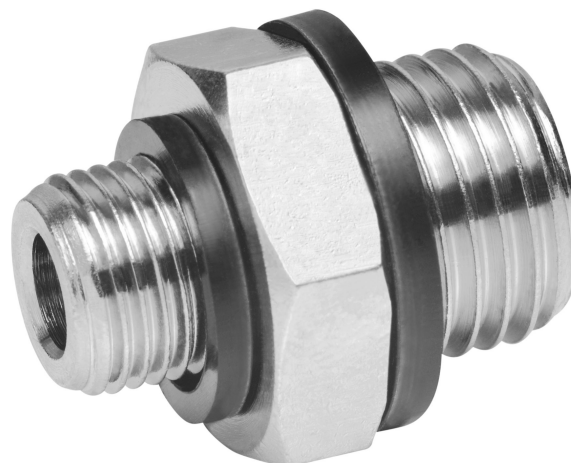

### Technical data

Industry	Industrial
Compressed air connection type	External thread
Port G	G 1/2
Compressed air connection type 2	External thread
Port D	G 3/8
Type	FPT-S-RDO
Min. working pressure	0 bar
Max. working pressure	16 bar
Min. ambient temperature	-20 °C
Max. ambient temperature	80 °C
Delivery unit	5 piece

### Material

Material	Brass
Surface	nickel-plated
Seal material	Polyvinyl chloride
Surface seals	hard
Part No.	1823391020

# Double nipple

2024-03-21

1823391020

## Dimensions

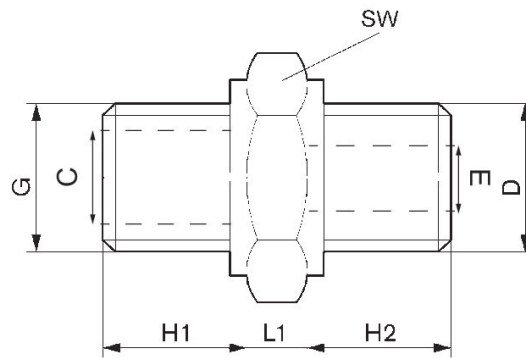

Part No.	Port D	Port G	ØC	ØE	H1	H2	L1	SW
1823391081	M5	M5	-	2	4.5	4.5	4	8
1823391100	M5	G 1/8	-	-	7	5	5	13
1823391015	G 1/8	G 1/8	8	5	7.5	7.5	4	14
1823391016	G 1/8	G 1/4	8	5	10	7	5	17
1823391017	G 1/4	G 1/4	8	7.5	10	10	5	17
1823391018	G 1/4	G 3/8	12	7.5	10	10	5	22
1823391019	G 3/8	G 3/8	12	10	10	10	5	22
1823391020	G 3/8	G 1/2	15	10	12	10	6	27
1823391029	G 1/2	G 1/2	15	13	12	12	6	27
1823391286	G 1/2	G 3/4	20	13	12	12	7	32
1823391287	G 3/4	G 3/4	20	18	12	12	7	32
1823391288	G 3/4	G 1	25	18	15	12	8	41
1823391289	G 1	G 1	25	22	15	15	8	41