

Racor recto, con anillo obturador

1823386039

Accesorios
de válvula

2024-08-13

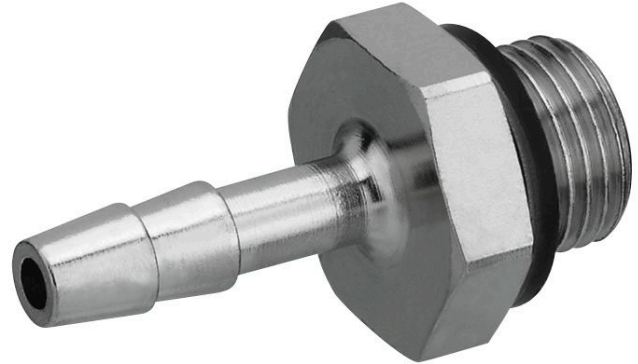

Datos técnicos

Sector	Industria
Hueco LW	8 mm
Orificio G	G 1/2
Unidad de suministro	5 Unidades
Peso	0.048 kg

Material

Material carcasa	Latón
Superficie Carcasa	niquelado
N° de material	1823386039

Racor recto, con anillo obturador

1823386039

Accesorios
de válvula

2024-08-13

Dimensiones



Dimensiones en mm

			H	L1	L2	SW
1823386007	G 1/8	4 mm	5	15.5	7.5	7
1823386007	G 1/8	4 mm	7	28	17	14
1823386008	G 1/8	6 mm	7	33	22	14
1823386009	G 1/8	8 mm	7	33	22	14
1823386012	G 1/4	4 mm	9	30	17	17
1823386013	G 1/4	6 mm	9	35	22	17
1823386014	G 1/4	8 mm	9	35	22	17
1823386036	G 3/8	6 mm	9	36	22	19
1823386037	G 3/8	8 mm	9	36	22	19
1823386038	G 3/8	13 mm	9	42	28	19
1823386039	G 1/2	8 mm	12	40	22	27
1823386040	G 1/2	13 mm	12	46	28	27
1823386041	G 3/4	13 mm	16	52	28	32
1823386042	G 3/4	19 mm	16	60	36	32