

Vis d'obturation et connecteurs AVENTICS



Données techniques

Secteur	Industrie
Type de raccordement d'air comprimé	Taraudage
Orifice G	G 3/8
Type de raccordement d'air comprimé 2	Taraudage
Orifice D	G 3/8
Type	FPT-S-RSK
Pression de service min.	0 bar
Pression de service maxi	16 bar
Température ambiante min.	-20 °C
Température ambiante max.	80 °C
Unité de livraison	10 Pcs.

Matériau

Matériau	Laiton
Surface	nickelé
Référence	1823300002

Dimensions

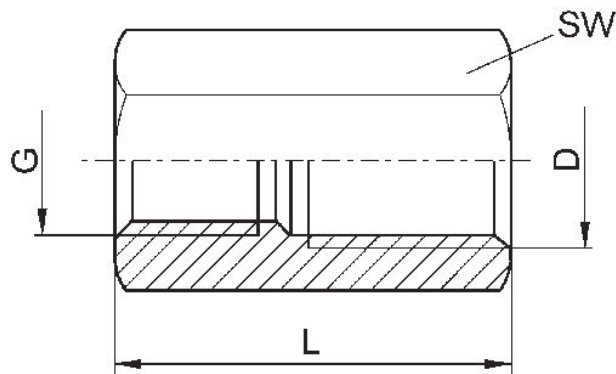

Référence	Orifice D	Orifice G	L	SW
1823300012	M5	M5	10	8
8932403214	G 1/8	M5	14	14
R412010028	M8	M8	15	11
1823300000	G 1/8	G 1/8	15	13
1823300001	G 1/4	G 1/4	22	17
1823300002	G 3/8	G 3/8	22	22
1823300008	G 1/2	G 1/2	26	27
1823300035	G 3/4	G 3/4	34	32
1823300036	G 1	G 1	38	41
1823373084	G 1/8	M10x1,25	31	13
1823373085	G 1/4	M10x1,25	34	17
1823373086	G 1/8	M12x1,25	31	17
1823373087	G 1/4	M12x1,25	34	17