

AVENTICS Blanking screws and connectors



Technical data

Industry	Industrial
Compressed air connection type	Internal thread
Port G	G 3/8
Compressed air connection type 2	Internal thread
Port D	G 3/8
Type	FPT-S-RSK
Min. working pressure	0 bar
Max. working pressure	16 bar
Min. ambient temperature	-20 °C
Max. ambient temperature	80 °C
Delivery unit	10 piece

Material

Material	Brass
Surface	nickel-plated
Part No.	1823300002

Sleeve

1823300002

2024-03-21

Dimensions

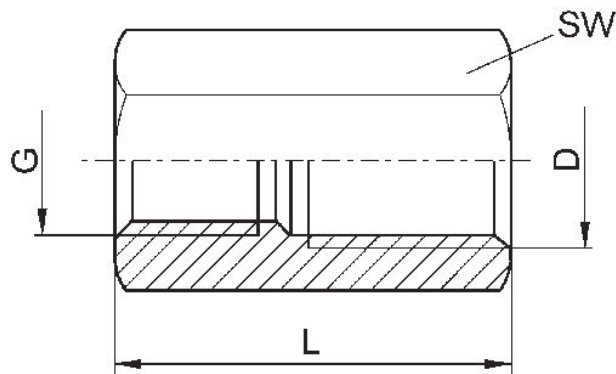

Part No.	Port D	Port G	L	SW
1823300012	M5	M5	10	8
8932403214	G 1/8	M5	14	14
R412010028	M8	M8	15	11
1823300000	G 1/8	G 1/8	15	13
1823300001	G 1/4	G 1/4	22	17
1823300002	G 3/8	G 3/8	22	22
1823300008	G 1/2	G 1/2	26	27
1823300035	G 3/4	G 3/4	34	32
1823300036	G 1	G 1	38	41
1823373084	G 1/8	M10x1,25	31	13
1823373085	G 1/4	M10x1,25	34	17
1823373086	G 1/8	M12x1,25	31	17
1823373087	G 1/4	M12x1,25	34	17