

AVENTICS Gabelköpfe



Technische Daten

Branche

Industrie

Für Serie

für Gelenkkopf AP6

Für Serie

AP6

Gelenklager-Ø

16 mm

Werkstoff

Werkstoff Gehäuse

Stahl, verchromt

Oberfläche Gehäuse

verzinkt

Materialnummer

1822122033

Gabelkopf PM6, Serie CM2

1822122033

Gabelköpfe

2023-10-05

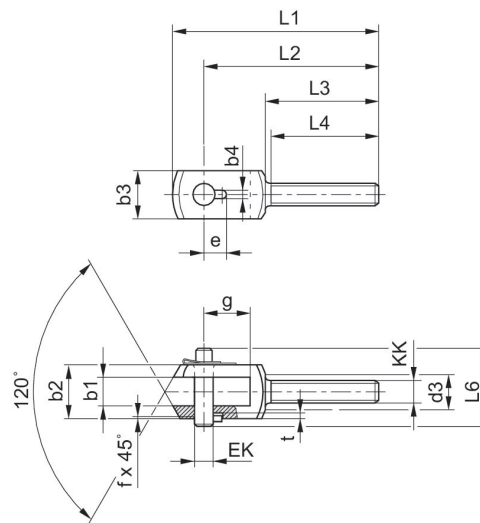

KK	Material-nummer	b1 B12	b2 d12	b3	b4 +0,2	d3	e +0,3	EK	f
14	1822122032	14	28	20	3.3	17	11.5	10	0.7
16	1822122033	16	30	25	4.3	19	12	12	1
21	1822122034	21	40	35	4.3	24	14	16	1
25	1822122035	25	50	40	4.3	30	16	20	1
30	1822122036	37	67	60	6.3	38	24	30	1.5

KK	g	L1	L2	L3	L4 +1	L6	t +0,2
14	20	90	78	53	50	35	3
16	26	108	92	58	55	39	3
21	31	129	108	65	62	50	3
25	43	156	131	73	69	60	3
30	54	200	168	98	92	77	5