

Rod clevis AP2, Series CM2

1822122009

Rod
clevises

2023-10-05

AVENTICS Rod clevises

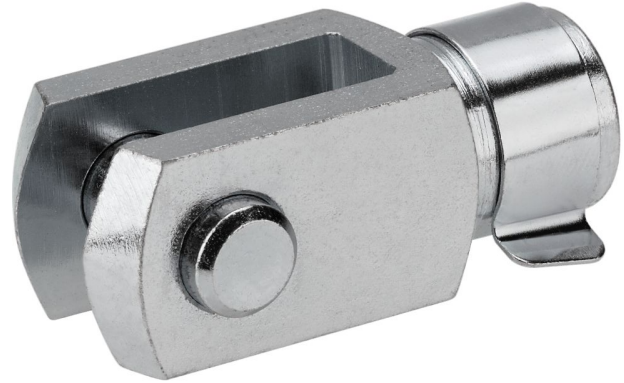

Technical data

Industry

Industrial

For series

to mount on cylinder PRA, TRB, CCI, MNI, ICM, KPZ, KHZ, 167, CVI, RPC, RDC, ITS

For series

CCI
MNI
ICM
KHZ

Thread size

M6

Weight

0.02 kg

Material

Housing material

Steel, chrome-plated

Surface housing

galvanized

Part No.

1822122009

Rod clevis AP2, Series CM2

1822122009

Rod
clevises

2023-10-05

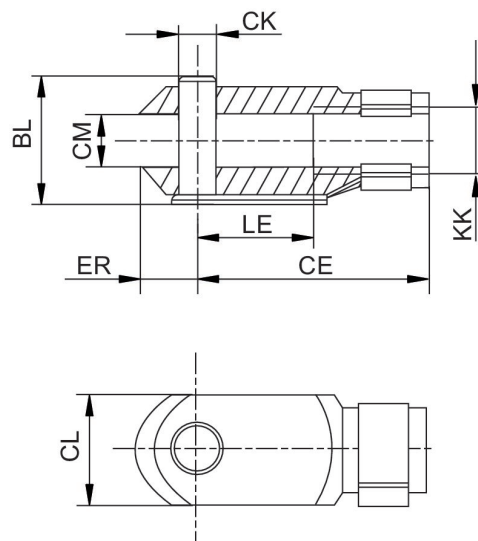

KK	Part No.	BL	CE	ØCK e11	CL	CM	ØD1	ER	LE
M4	1822122028	11	16	4	8	4	8	5	8
M6	1822122009	16	24	6	12	6	10	7	12
M8	1822122010	21,5	32	8	16	8	14	10	16
M10x1,25	1822122024	26	40	10	20	10	18	12	20
M12x1,25	1822122025	31	48	12	24	12	20	14	24
M16x1,5	1822122005	39	64	16	32	16	26	19	32
M20x1,5	1822122004	50	80	20	40	20	34	20	40
M10	8958000122	26	40	10	20	10	18	12	20
M12	8958000132	31	48	12	24	12	20	14	24
M48x2	8958019332	122	192	50	96	50	82	73	96
M5	1822122008	13,5	20	5	10	5	9	6	10