

AVENTICS Fußverbindungen



Technische Daten

Branche
Normierung
geeigneter Kolbendurchmesser

Industrie
ISO 6432
8 mm
10 mm

Werkstoff

Werkstoff Gehäuse
Oberfläche Gehäuse
Materialnummer

Stahl, verchromt
verzinkt
1821332029

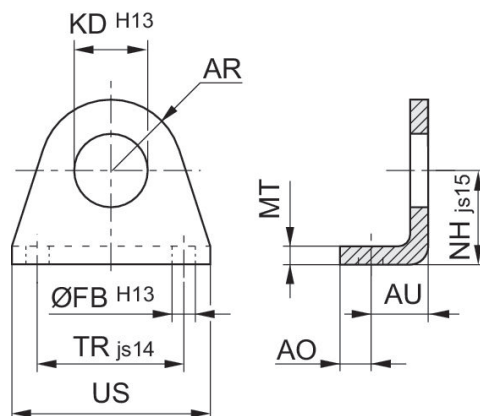

Kolben-Ø	Materialnummer	AO	AR	AU	Ø FB H13	Ø KD H13	MT	NH ±0,3 js15	TR js14
8, 10	3322210000	5	10	11	4.5	12	3	16	25
8, 10	1821332029	5	10	11	4.5	12.1	3	16	25
12, 16	3322216000	6	12.5	14	5.5	16.1	4	20	32
12, 16	1821332028	6	13	14	5.5	16.1	4	20	32
20, 25	3322220000	8	20	17.5	6.6	22.1	5	25	40
20, 25	1821332027	8	20	17	6.6	22.1	5	25	40
32	3322232000	9	24	20	6.6	30.1	5	32	48

Kolben-Ø	US
8, 10	35
8, 10	35
12, 16	42
12, 16	42
20, 25	54
20, 25	54
32	65