

Tubing clamp for reinforced plastic tubing, DIN 3017 form A

2024-05-06

1821310000

Tubing clamp for reinforced plastic tubing, DIN 3017 form A



Technical data

Industry	Industrial
Type	Ø 20-32
Clearance (LW)	19 mm
Delivery unit	25 piece
Weight	0.014 kg

Material

Housing material	Stainless Steel
Part No.	1821310000

Technical information

Materials: band and housing made of chrome steel 1.4016, screw made of yellow chromated steel Cq15. Category W2: low to medium corrosion resistance requirements, but detachability of corroded connections is ensured.

Tubing clamp for reinforced plastic tubing, DIN 3017 form A

2024-05-06

1821310000
Dimensions

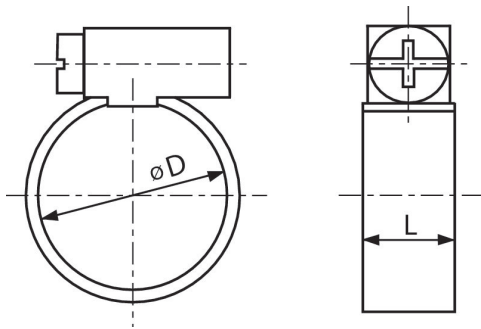

Part No.	$\varnothing D$	L
1821310002	8-12	9
1821310001	10-16	9
1821310003	12-20	9
1821310000	20-32	9