

# Spring-loaded plunger, Series PSL

2024-04-05

0821305171

## Series AS5

Qn = 14500 l/min



## Technical data

Industry	Industrial
Type	not non-rotating
Min. ambient temperature	0 °C
Max. ambient temperature	80 °C
Spring rate	0.596 N/mm
Spring pre-tensioning	1.49 N
Max. vertical load (static)	550 N
Max. horizontal load (static)	47 N
Bending moment	0.7 Nm
Weight	0.009 kg
Housing material	Steel, chrome-plated
Surface housing	galvanized
Material guide insert	Brass
Material spring	Steel, chrome-plated
Material nut	Steel, chrome-plated
Part No.	0821305171

## Technical information

The pressure dew point must be at least 15 °C less than ambient and medium temperature and may not exceed 3 °C.

The oil content of compressed air must remain constant during the life cycle.

Use only the approved oils from AVENTICS. Further information can be found in the “Technical information” document (available in <https://www.emerson.com/en-us/support>).

Fig. 1

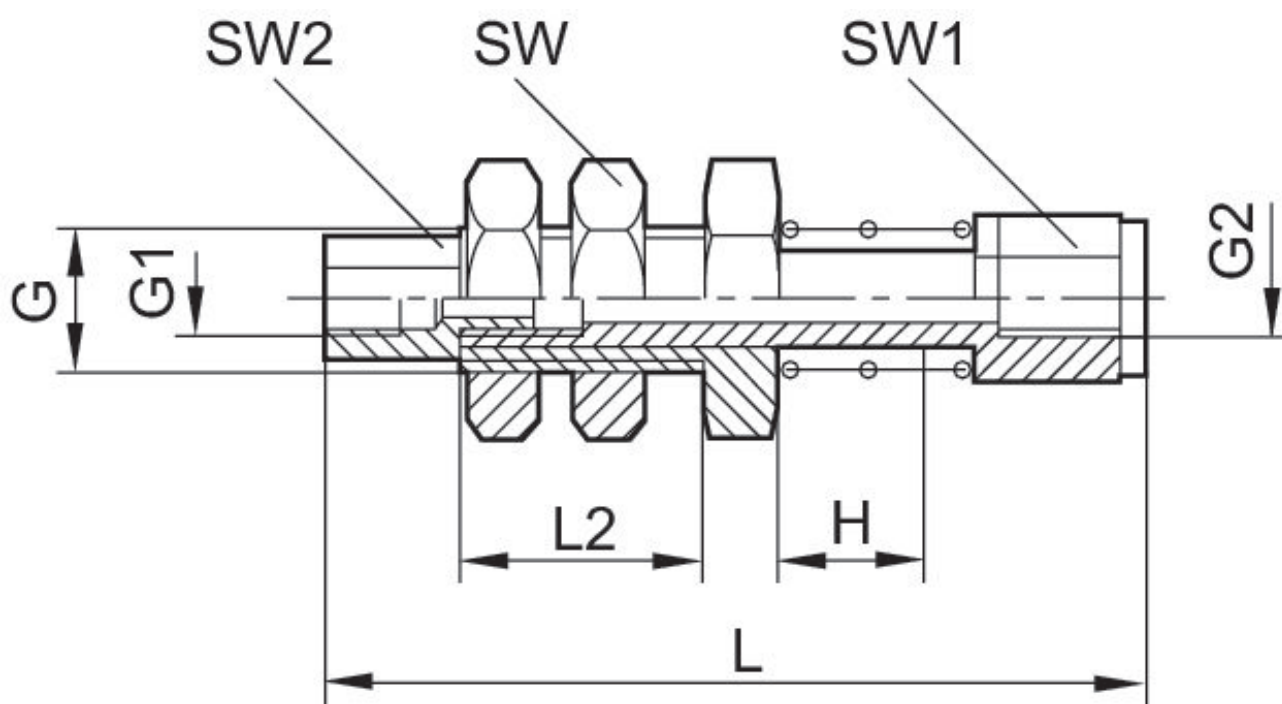

H = stroke

Part No.	G	G1	G2	H	L	L2	SW	SW1	SW2
0821305171	M6x0,75	M3	M3	5	33.5	10	10	7	4.5
0821305172	G 1/8	M5	M5	10	47.2	15	14	7	7