

AVENTICS Series NR02 Non-return valves

AVENTICS Series NR02, thanks to an array of connection options, the NR non-return valves can be screwed in separately and are also suitable for direct installation in piping. NR02 non-return valves are pneumatically pilot operated.



Technical data

Industry	Industrial
Type	Poppet valve
Mounting	installing in piping
Compressed air connection 1	G 1/4
Compressed air connection type 1	Internal thread
Compressed air connection 2	G 1/4
Compressed air connection type 2	Internal thread
Compressed air connection 12	G 1/8
Nominal flow Qn 1 to 2	510 l/min
Nominal flow Qn 2 to 1	400 l/min
Min. working pressure	1 bar
Max. working pressure	12 bar
Min. ambient temperature	-10 °C
Max. ambient temperature	60 °C
Min. medium temperature	-10 °C
Max. medium temperature	60 °C
Medium	Compressed air
Weight	0.099 kg

Pilot-operated non-return valve, Series NR02

0821003026

Series
NR02

2024-01-24

Material

Housing material

Die cast zinc

Seal material

Acrylonitrile butadiene rubber

Part No.

0821003026

Dimensions

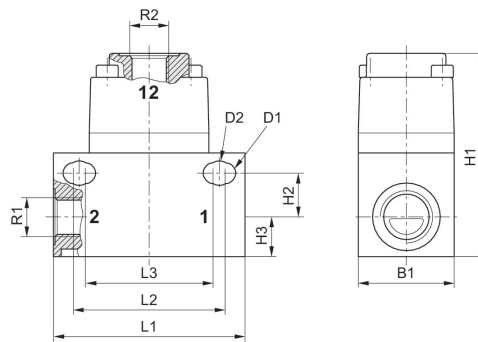

	R1	R2	Ø D1	Ø D2	L1	L2	L3	H1	H2
0821003025	G 1/8	G 1/8	5.2	6.1	48	38	32	51	11
0821003026	G 1/4	G 1/8	5.2	6.1	48	38	32	51	11

	H3	B1
0821003025	10	24
0821003026	10	24