

Multipole plug, series CON-MP

0493871408

Multipole plug with cable, series CON-MP

- Multipole plug connectors with connected cable
- Valve system control, D-Sub plug



Technical data

Industry
Industrial

Type
Multipole

Cable
with cable

Operational voltage
24 V DC

Operating voltage AC max.
24 V DC

Electrical connection 1, type
Socket

Electrical connection 1, thread size
C/2

Electrical connection 1, number of poles
48-pin

Cable exit
angled

Cable exit angle
45°

Electrical connection 2, type
open cable ends

Electrical connection 2, number of poles
24-pin

Number of wires
25

Shielding
unshielded

Cable length
15 m

Protection class
IP69K

Min. ambient temperature
0 °C

Max. ambient temperature
50 °C

Max. current
3 A

Wire cross-section
0.34 mm²

Cable-Ø
9.2 mm

Weight
2.84 kg

Material

Housing material
Polyamide

Part No.
0493871408

Material cable sheath
Polyvinyl chloride

Technical information

The specified protection class is only valid in assembled and tested state.
max. 8 valves

Dimensions

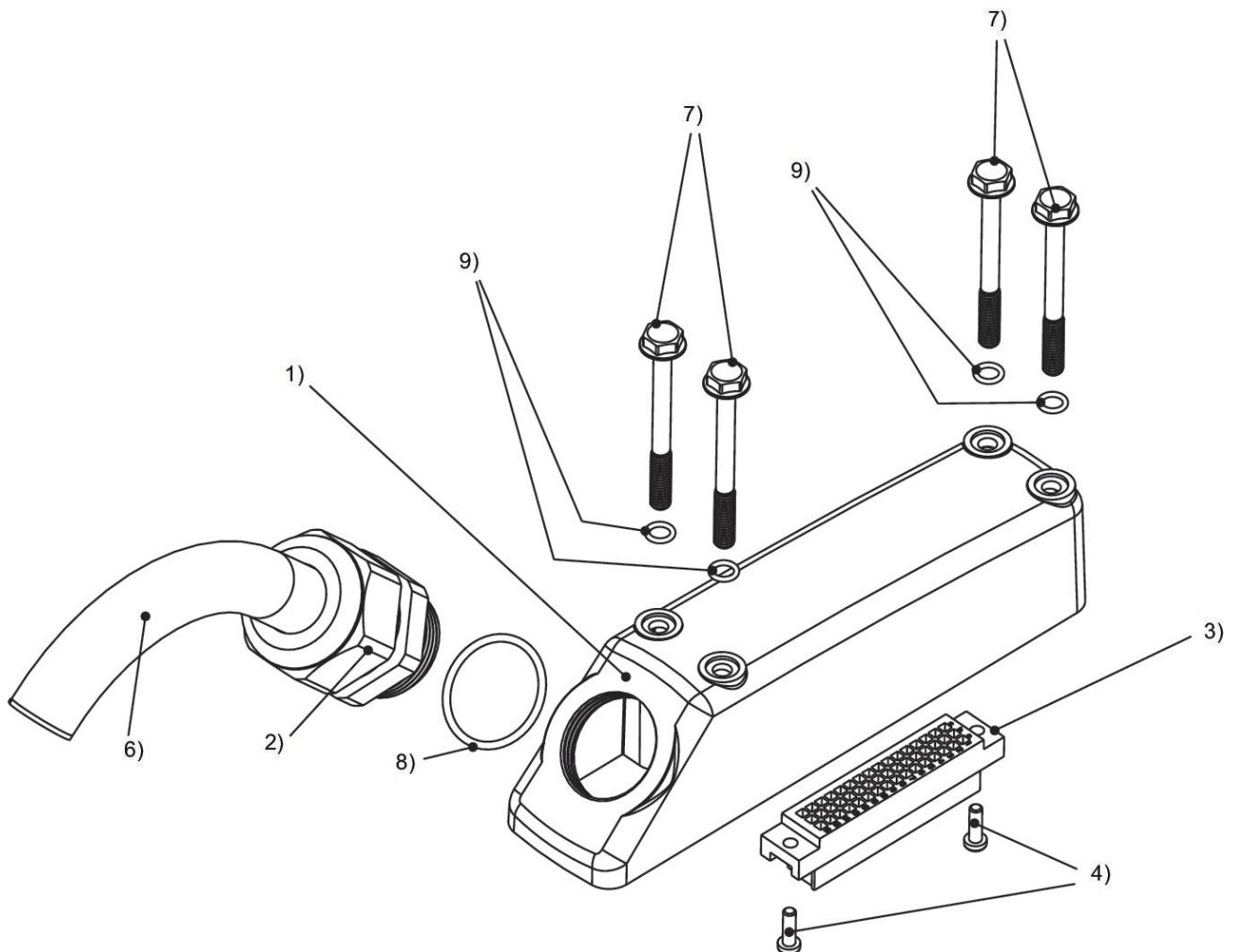

1) housing 2) cable gland 3) connector housing size C/2 4) screw 5) seal 6) cable 7) screw 8) seal 9) seal

PIN assignment and cable colors

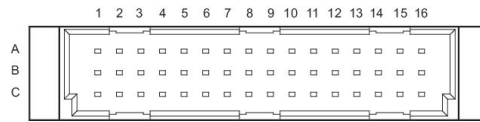

PIN assignment and cable colors, 24-pin

Pin Color	A	B	C
1	blue	white	brown
2	red/blue	green	yellow
3	white/pink	gray	pink
4	pink/brown	red	black
5	white/blue	violet	gray/pink
6	brown/blue	white/green	brown/green
7	white/red	white/yellow	yellow/brown
8	brown/red	white/gray	gray/brown